

NOTE: If the fuse panel on your 510125 Mustang kit dash harness looks like the drawing at the left, you have the second design harness and your instructions follow this title page.



**American
Autowire**

www.americanautowire.com 856-933-0801

64-6 Mustang Second Design Instructions

92972204 rev. 0.0 7/30/2018



WARNING:

Validate the kit contents with the component list included on this page, before proceeding. This kit is intended to be used in a modified vehicle. Please read this page thoroughly and be sure that you understand everything explained on it prior to opening any of the enclosed packages, or before attempting to install any of the components. Once this kit has been opened or a component installed, the kit is not returnable.

1. This kit should typically be used in a **MODIFIED 1964-1966 Mustang** application only.
2. Some early production 1964 1/2 Mustangs used a unique headlight switch assembly that utilized a shorter knob and shaft assembly than the later production 1965 - 66 cars used (3.63" vs. 3.90"). The new AAW switch included with this kit is an exact replacement for the later 1965-66 cars and needs the later production style knob and shaft in order to operate. If your car is an early production 1964 1/2 model, you will need to purchase the newer long style knob and shaft assembly from your favorite Mustang parts supplier as your original will be too short to operate the new AAW switch assembly..
3. This kit **DOES NOT** support the use of the stock generator warning lamp. A voltmeter is recommended as a good source to monitor your charging system.
4. This kit only supports the use of a higher current self-exciting 1 wire, or other style internally regulated alternator. An adapter may be necessary for certain applications. **No stock alternators are supported.**
5. This kit **WILL NOT** support the use of a factory ammeter. All AAW kits are engineered to supply the optimum charge to the battery. To achieve this performance, we route our 6ga. charge wire directly from the alternator output terminal to the starter solenoid. Due to the path of the charge being altered from the stock configuration, the gauge can no longer see a charge vs. a discharge, so it will not work properly. When ammeters were originally used, most generator or alternator current outputs were rated at maximum of about 25-60 amps. Modified cars being built today typically utilize a 100 amp or higher output alternator. With these higher current units, ammeters, generally speaking, become a safety hazard. Ammeters are usually wired in parallel to the charging circuit, are typically unfused, and can short very easily causing a fire. A voltmeter is recommended as a good alternative.
6. This kit **WILL NOT** support the use of a factory tachometer in it's original connection application as those tachs wired the primary ignition circuit directly in series through the tach and then out to the positive side of the coil. With this type of connection, any type of MSD or high energy ignition will generally destroy the internal circuitry of the tach and will cause the car to quit running as voltage will no longer flow through the tach and out to the coil or ignition control unit. **HOWEVER**, if your factory tach has been upgraded or retrofitted to a later style movement where the pulse post on the tach gets wired to the negative side of the coil (or to the tach output on an MSD box or similar unit) and the feed post of the tach uses a conventional 12 volt ignition connection, **you will be able to use this harness system.**
7. This kit **IS NOT** set up with a resistance wire for a standard, points type ignition system. It is wired with a full 12 volt primary ignition feed that is hot in both the start and run positions. It will support HEI, MSD, other electronic ignition systems, as well as computerized Fuel Injection systems. If you wish to run a points type system, there are illustrations on the engine connection pages to do so. Extra parts that are not included in this kit will be required to complete that operation.

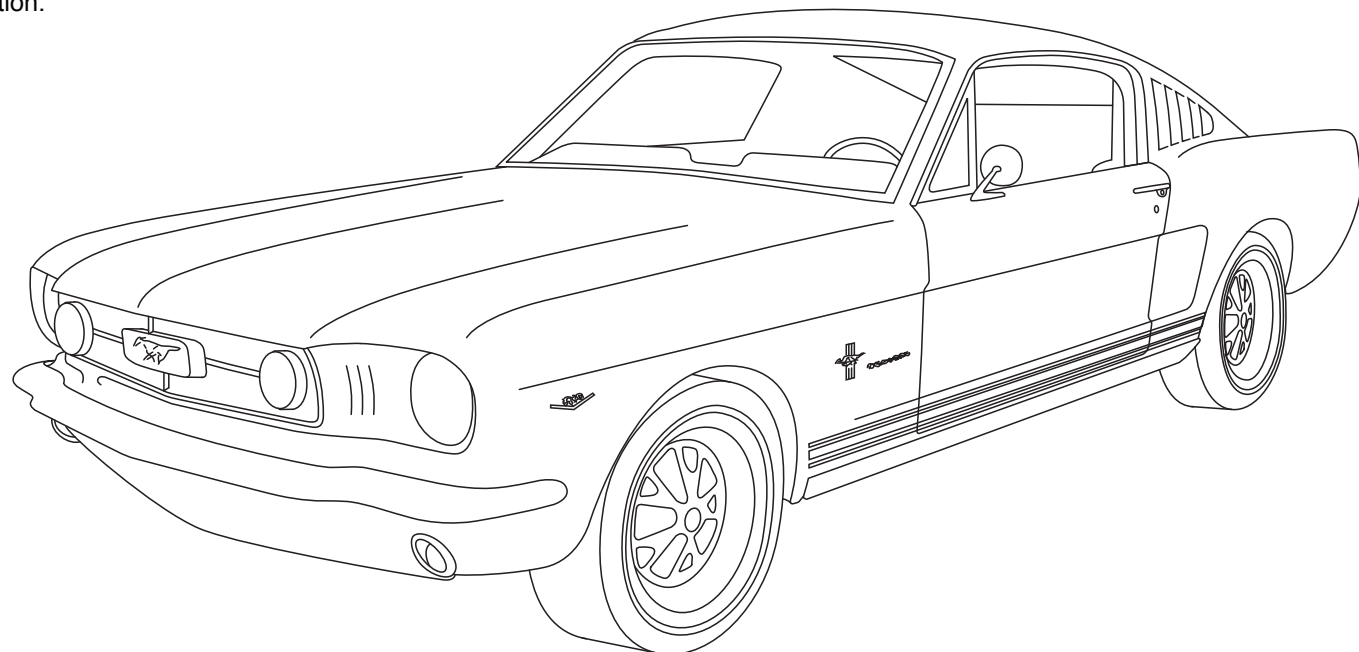

510125 - Classic Update Series Kit 1964-66 Mustang

This kit contains the following components:

Bag	Part Number	Description	Quantity
	510054	Headlight Switch	1
	510469	Fuse, Relay, and Flasher kit	1
	500042	Dimmer Switch	1
	510128	Ignition Switch	1
	500919	Practice Terminal Crimping Set	1
G	510467	Dash Harness kit	1
H	510461	Instrument Cluster wiring kit	1
J	510466	Engine Wiring Kit	1
L	510465	Front Light Wiring kit	1
M	510468	Rear Body Wiring kit	1
Z	510476	Alt. & Main Power Connection Kit	1

Validate the kit contents with this component list. If there are any discrepancies with incorrect or missing parts, stop your installation and notify the supplier you purchased the kit from before proceeding.



American Autowire

www.americanautowire.com 856-933-0801

1964-66 Mustang
Classic Update Series
510125

© COPYRIGHT 2004 American Autowire / Factory-Fit
Used with express permission of
American Autowire / Factory-Fit

92972102 Rev 4.0 5/8/2020

START HERE !

PLEASE READ THIS BEFORE STARTING INSTALLATION !

This wiring kit is designed for ease of installation. Please read the guidelines below, BEFORE STARTING your installation, to guarantee a successful job. Use an appropriate crimping tool, which folds the wings of the open barrel terminals down into the wire, as shown on this page. If you use our crimping tools and correctly crimp the included terminals, soldering is not necessary. If you are unsure about a particular crimp, soldering is recommended. Our factory crimped terminations are installed by GM approved five ton presses, and soldering these terminations is not necessary.



AAW offers a great terminal crimping video entitled "Proper Crimping Video". It can be viewed by visiting YouTube.

Type the following address into your web browser, to go directly to the video:
www.youtube.com/watch?v=JAgEDoVI-co

Youtube Channel:
www.youtube.com/user/WiringHarness



The terminals that we supply in our kits, utilize what is known as an F crimp. The F crimp, in a cross section, will look like the illustration below, when done correctly.

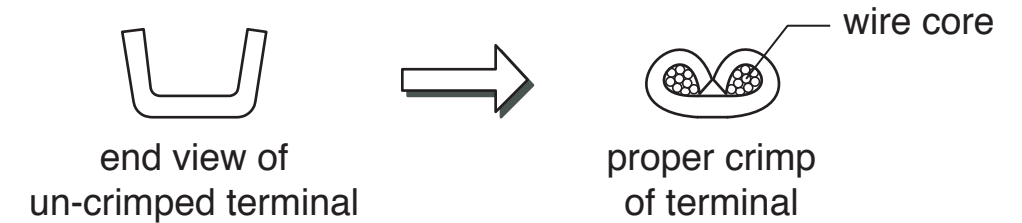

We carry the following crimping hand tools, to help with your terminal crimping. These hand tools are available, for purchase or rental.

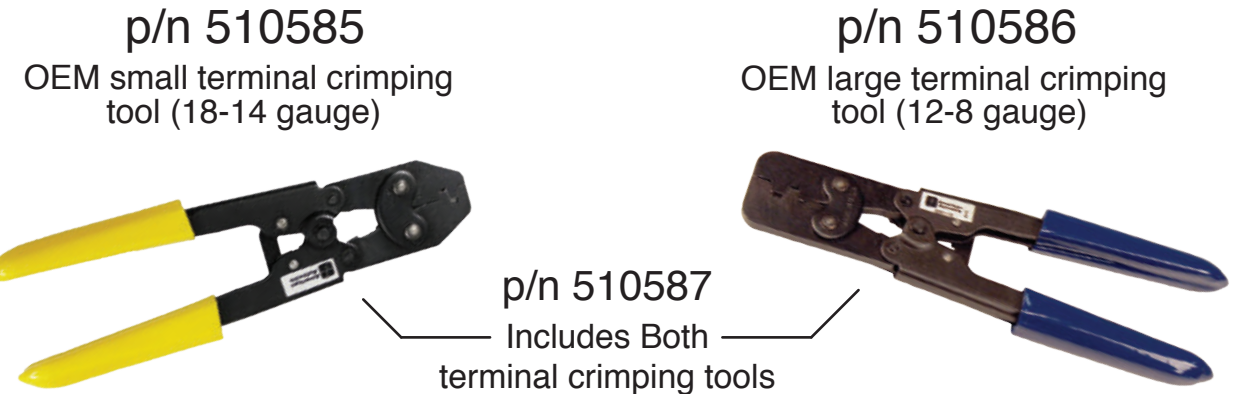

We carry many accessories for your 1964-66 Mustang:



p/n 510175
factory hazard switch
wiring kit



p/n 510127
ignition switch lock
cylinder and keys



p/n R0067108
OEM style non-stick
harness tape

STEP 1: DISCONNECT YOUR BATTERY:

Disconnect the battery, before installing the wiring kit, to prevent any accidental shorting caused by loose bare wire ends.



If you have any questions concerning this or any of our products, please feel free to call us at 1-856-933-0801.

STEP 2: START INSTALLING KIT:

This kit is broken down into individual sections, that are identified by a letter printed on the enclosed sheets, visible through each bag. The order of installation and the pages with their installation instructions, are shown below:

Table of Contents:

Bags: Pages: Sections:

- G 4 - 9 Dash Harness - This is the main harness in the kit and contains:**
- Heater feed and switch connections.
 - Door jamb switch and door courtesy feed connections.
 - Ignition, lighting, dimmer switch and wiper feed connections.
 - Neutral safety and back up light switch connections.
- H 10 - 14 Gauge Cluster Harness - This Harness contains:**
- Gauge connections for aftermarket and factory gauges.
- J 15 - 16 Engine Harness - This Harness contains:**
- Temperature, oil pressure, tachometer wiring.
 - Ignition system / ECU power.
 - Alternator connections.
 - Starter solenoid connections.
 - Main panel feed connections.
- L 17 - 18 Front Light Harness - This Harness contains:**
- Headlight, turn signal, running light connections.
 - Electric fan relay trigger.
 - Fog light connections.
 - Brake warning light connections.
 - Horn connections.
- M 19 - 20 Rear Body Harness - This Harness contains:**
- Tail light, turn signal, reverse light, running light and third brake light connections.
 - Fuel tank sender connections.
 - Dome light connections.



PLEASE READ THIS HELPFUL INSTALLATION TIP, BEFORE GOING ANY FURTHER!

Prior to installing the Dash/Main harness in your dashboard, plug all of the fuses into the Fuse Box (see detailed picture below) and the Hazard Flasher and Turn Flasher and Headlights, Fog Lights and Horn Relays into this harness (see detailed pictures below).

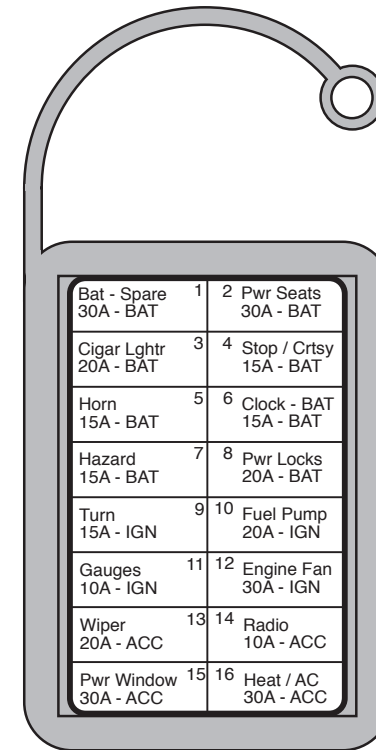

Fuse label
on inside
of Fuse
Box cover

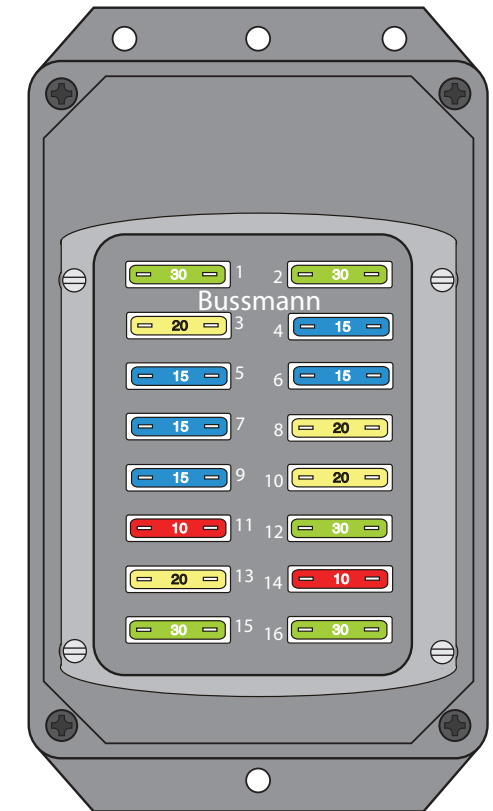

Fuse
Installation
Locations

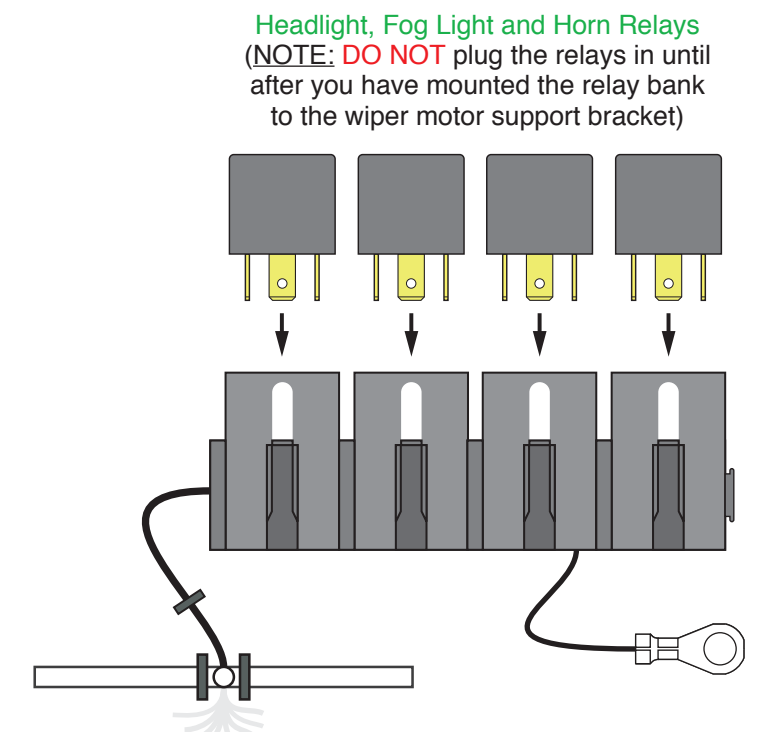
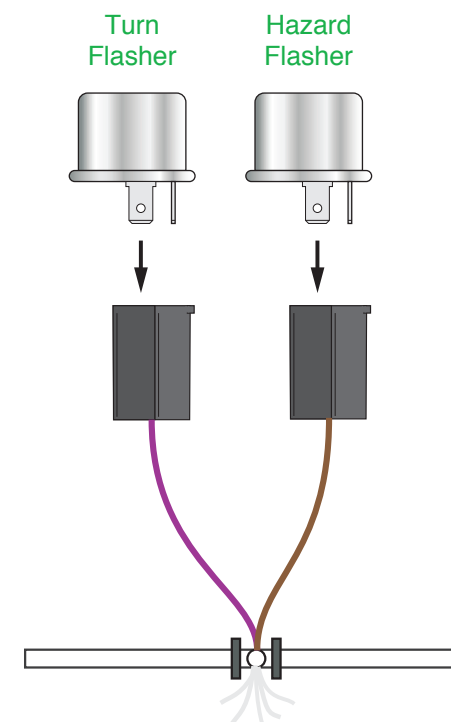

Dash/Main harness installation instructions:

Shown below, are the supplied misc. terminals, plastic connector bodies, hardware, jumpers and extensions, included in the Dash/Main Harness and Loose Piece bags, that will be used to complete your Dash/Main harness connections. They are itemized and referred to on this page, just as they are on the following pages of this Dash/Main instruction set.

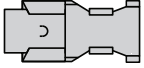
A  (56 series double female terminal, 8 pcs.)

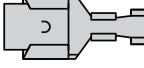
B  (56 series single female terminal, 3 pcs.)

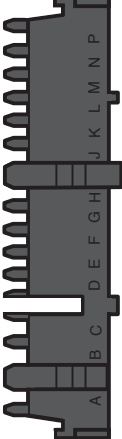
C  (Pack-Con 14-way male connector, 1 pc.)

D  (Pack-Con male terminal, 11 pcs.)

E  (fuse panel mounting bracket, 1 pc.)

F  (1" fuse box mounting screw, 2 pcs.)

G  (1/4" lock washer, 2 pcs.)

H  (8-32 x 9/16 Phillips screw, 3 pcs.)

J  (8-32 locking nut, 3 pcs.)

K  (#10 flat washer, 3 pcs.)

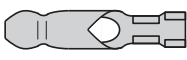
L  (male bullet terminal, 3 pcs.)

M  (small rubber sleeve, 3 pcs.)

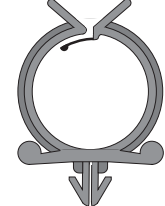
N  (routing clip, 2 pcs.)

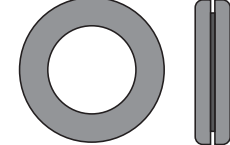
P  (grommet, 2 pcs.)

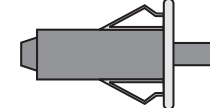
R  (door jamb switch, 2 pcs.)

T  (3-way female connector, 1 pc.)

U  (58 series single female terminal, 5 pcs.)

V  (58 series single female connector, 1 pc.)

W  (single female terminal, 2 pcs.)

Y  (large rubber sleeve, 1 pc.)

BB  (NSS jumper wire for manual trans, 1 pc.)

CC  (NSS wires from dash connection to switch, 2 pcs.)

DD  (1964-68 high speed blower wire, 1 pc.)

EE  (1964-65 low speed blower wire, 1 pc.)

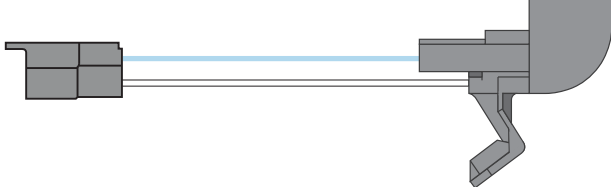
FF  (Courtesy Light Wiring Extensions, 2 pcs.)

GG  (B/U wires from dash connection to switch, 1 pc.)

Dash/Main fusebox /bracket/ harness assembly mounting instructions:



www.americanautowire.com 856-933-0801

1964-66 Mustang
Classic Update Series
510125 92972102 Rev 4.0 5/8/2020

1. Make sure you have installed all of your fuses into the fusebox. Assemble the mounting bracket to the fusebox and harness assembly as shown in step #1 on this page.
2. Attach completed "bracket, fusebox and harness assembly" into the vehicle as shown in steps #2 through #6 on this page.
3. Plug H/L switch 510054 into harness connector and install into your dash. Plug your existing wiper harness into the white wiper feed wire on the AAW dash harness, onto your existing wiper switch and over to your wiper motor.
4. Plug ignition switch 510128 into harness connector, attach brown wire with ring terminal to threaded stud, plug tan wire onto ground blade of the ignition switch and install completed assembly into your dash. Plug in your cigar lighter connection.
5. Route the front light and dimmer connections back around the fresh air vent so that the front light connections are at the pass-through hole in the firewall, then route the dimmer connections down to the floor area and attach to dimmer switch 500042. Secure dimmer switch to the toeboard/floor. Plug in front light wiring 510465. After installing firewall grommet "P" in the opening, route wires out to the engine bay. See pages 18 and 19 for details.
6. Drop rear body connector down inside the door hinge pillar to the floor. Plug your in rear body harness 501468, then it route along the door sill back to the trunk area. See pages 20 and 21 for connection details.
7. Plug brake switch connection onto your existing brake switch.
8. From page 10, assemble NSS and B/U switch extension and plug onto dash harness connection.
9. Route the engine connections to the pass-through hole in the firewall. Plug in engine harness wiring 510466. After installing firewall grommet "P" in the opening, route wires out to the engine bay. See pages 16 and 17 for details. Make LH door switch and courtesy lamp (to right of column) connections. See pages 6 and 9 for details.
10. Plug in your steering column connections. See page 8 for details.
11. Build your gauge cluster harness and plug the finished assembly into the dash harness connections as shown on page 6. See pages 11-15 for details on building your cluster harness. Please note that there are several different choices and be sure you have picked the proper choice for your car's application.
12. Mount relay bank to wiper motor support bracket. See template 92972156 for instructions and details.
13. Build your heat and A/C connections. See page 10 for details.
14. Pass remaining harness over past the radio and heater controls to the RH side of the car. Make radio, console, glove box, RH door switch and courtesy lamp connections as necessary. See pages 7 and 9 for details.



1. Assemble the mounting bracket to the fuse-loaded fusebox and harness assembly using screws, washers and nuts "H, J and K" found in the 92972060 dash loose piece kit.



2. Using mounting template and instruction sheet 92972154, drill a new .125 mounting hole in the door hinge pillar area.



3. With the cluster assembly and all the original wiring removed, lay the assembled "bracket, fusebox and harness assembly" from step 1 across your steering column as shown above.



4. Tuck the "bracket, fusebox and harness assembly" down inside the dash opening, and using screws and washers "F and G" found in the 92972060 dash loose piece kit, attach the assembly to the LH door hinge pillar area. Carefully route the harness to avoid any sharp edges on the LH vertical dash support so that you do not cut or chaff any wires.



5. Install the two harness routing clips "N" into the original holes near the top of the two vertical dash supports as shown above.



6. Snap the main harness into the two new harness routing clips "N" so that the harness routes over the cluster opening area as shown above. After you plug your wiper harness into the white AAW "wiper feed" wire from page 6, you can snap that harness into the two mounting clips as well.

Dash/Main harness installation instructions:

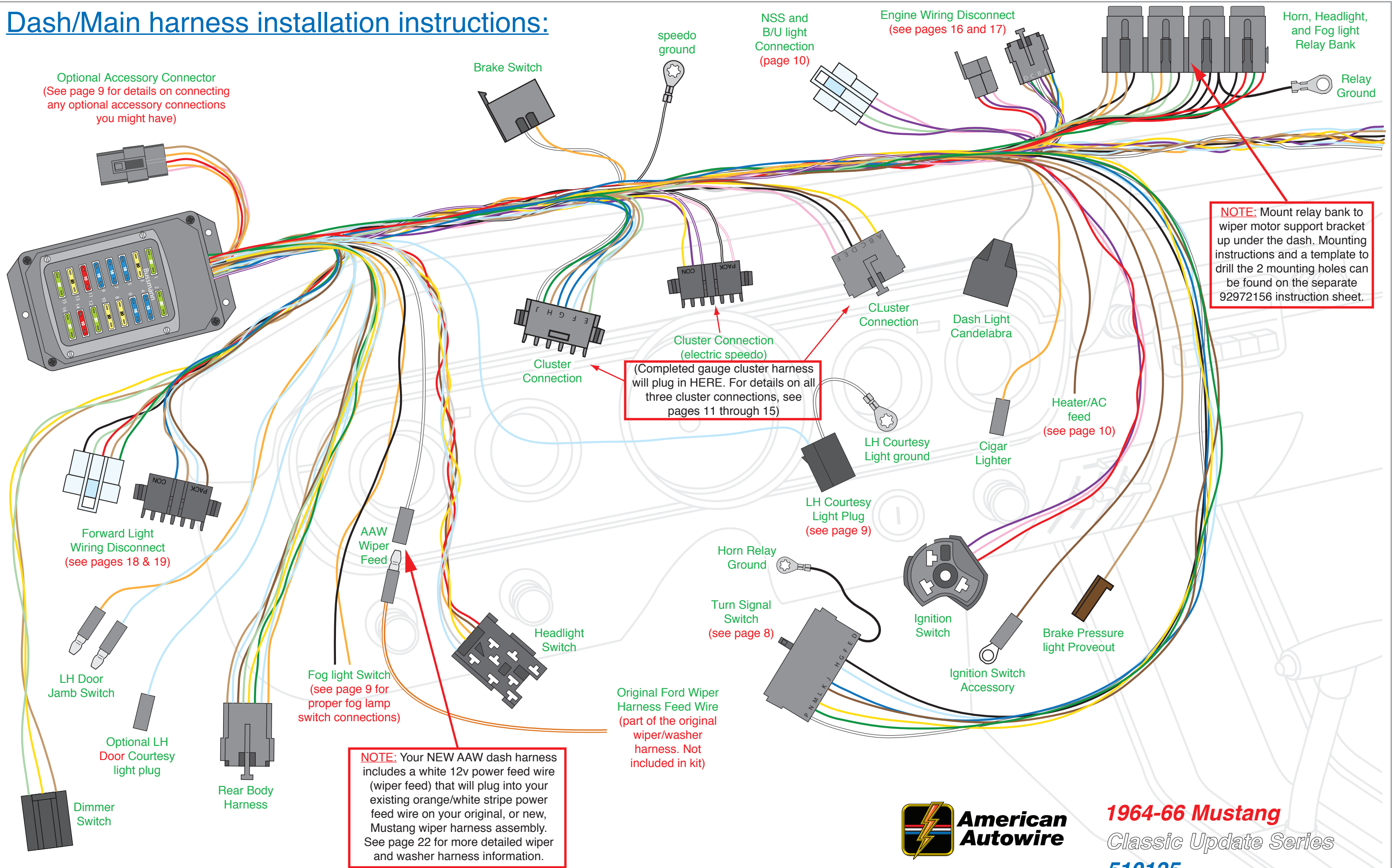

NOTE: Mount relay bank to wiper motor support bracket up under the dash. Mounting instructions and a template to drill the 2 mounting holes can be found on the separate 92972156 instruction sheet.

NOTE: (Completed gauge cluster harness will plug in HERE. For details on all three cluster connections, see pages 11 through 15)

NOTE: Your NEW AAW dash harness includes a white 12v power feed wire (wiper feed) that will plug into your existing orange/white stripe power feed wire on your original, or new, Mustang wiper harness assembly. See page 22 for more detailed wiper and washer harness information.



www.americanautowire.com 856-933-0801

1964-66 Mustang
Classic Update Series

510125 92972102 Rev 4.0 5/8/2020

Dash/Main harness installation instructions:

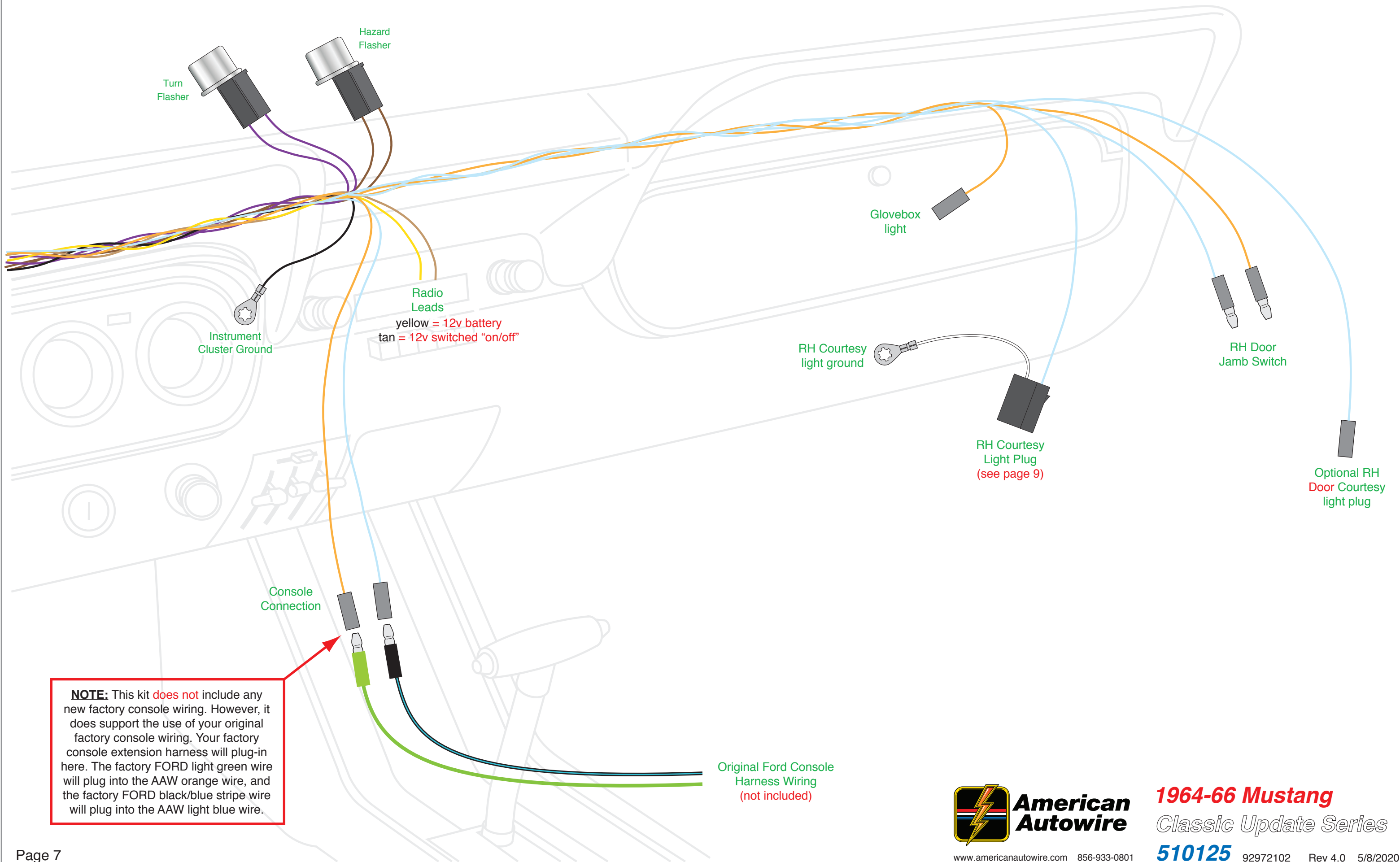

www.americanautowire.com 856-933-0801

1964-66 Mustang
Classic Update Series
510125 92972102 Rev 4.0 5/8/2020

Dash/Main harness installation instructions:

AMERICAN AUTOWIRE DASH HARNESS CONNECTION

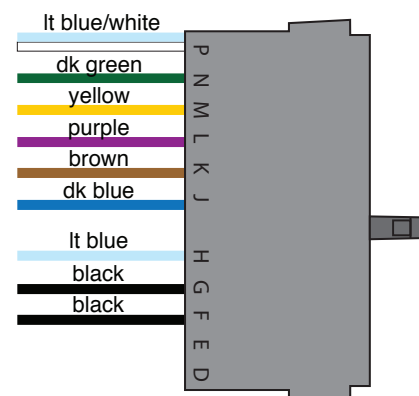

ORIGINAL TURN SIGNAL SWITCH WIRING

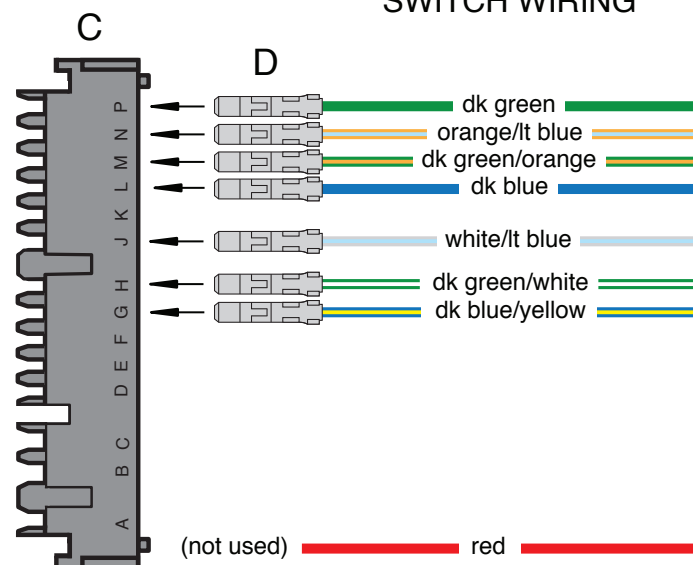

DIAGRAM 'A' - AAW Turn Signal Switch Wires to Stock 1964 Steering Columns.

"Table B"

AAW Turn Signal Switch wires to stock 1964 Ford Mustang Turn Signal Switch

AAW Wire Color	AAW Wire Printing	AAW Connector Cavity	FORD Wire Color
Lt Blue/White	Third Brake Light/Brake SW	P	Dark Green
Dark Green	Right Rear Turn	N	Orange/Lt. Blue
Yellow	Left Rear Turn	M	Dk. Green/Orange
Purple	Turn Switch Feed	L	Dark Blue
Brown	Turn SW – Hazard	K	Not Used
Dark Blue	Right Front Turn	J	White/Lt. Bue
Light Blue	Left Front Turn	H	Dk. Green/White
Black	Horn Relay Ground	G	Dk. Blue/Yellow
Black	Horn Relay Ground	F	Not used for 64 application
None	None	E	
None	None	D	
None	None	A	Red - Not Used)

Remove the original Turn Signal Switch Connector and replace it with the AAW 14-way connector "A". Crimp on terminal "B" to each of the original Turn Signal Switch wires and plug them into connector "A" (see Parts Kit 92972060). **(NOTE: Some replacement turn signal switches have a red wire in them that will not be used in this application)**

Use "Table B" above to align the wires. Also, for all of the 64 vehicles, the Steering Column Horn Button switches ground for the Horn Relay, which then switches power to the horns, exactly as original.

"Table B"

AAW Turn Signal Switch wires to stock 1965-66 Ford Mustang Turn Signal Switch

AAW Wire Color	AAW Wire Printing	AAW Connector Cavity	FORD Wire Color
Lt Blue/White	Third Brake Light/Brake SW	P	Dark Green
Dark Green	Right Rear Turn	N	Orange/Lt. Blue
Yellow	Left Rear Turn	M	Dk. Green/Orange
Purple	Turn Switch Feed	L	Dark Blue
Brown	Turn SW – Hazard	K	Not Used
Dark Blue	Right Front Turn	J	White/Lt. Blue
Light Blue	Left Front Turn	H	Dk. Green/White
Black	Horn Relay Ground	G	Yellow
Black	Horn Relay Ground	F	Yel./Green '65; Blue/Yel. '66
None	None	E	
None	None	D	
None	None	A	(Red - Not Used)

Remove the original Turn Signal Switch Connector and replace it with the AAW 14-way connector "C". Crimp on terminal "D" to each of the original Turn Signal Switch wires and plug them into connector "C" (see Parts Kit 92972060). **(NOTE: Some replacement turn signal switches have a red wire in them that will not be used in this application)**

"Table B" above to align the wires. Also, for all of the '65-'66 vehicles, the Steering Column Horn Button switches ground for the Horn Relay, which then switches power to the Horns.

AMERICAN AUTOWIRE DASH HARNESS CONNECTION

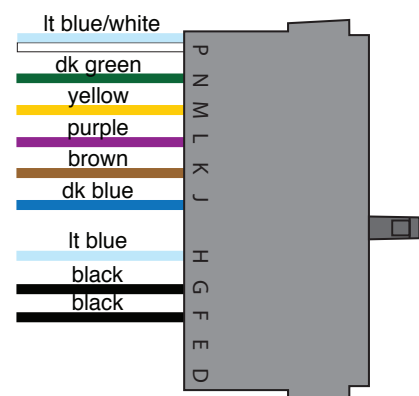

ORIGINAL TURN SIGNAL SWITCH WIRING

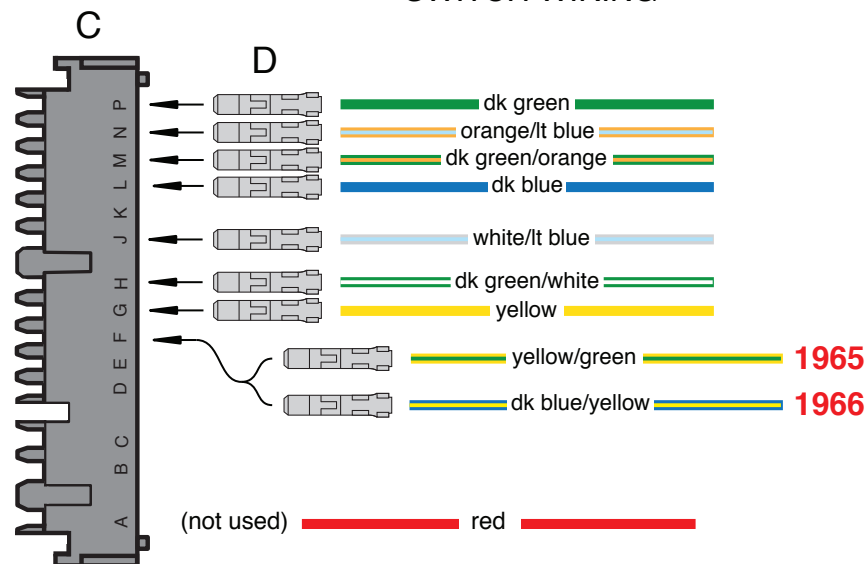

DIAGRAM 'A' - AAW Turn Signal Switch Wires to Stock 1965-66 Steering Columns.



www.americanautowire.com 856-933-0801

Dash/Main harness installation instructions:

Accessory connector wiring:

Use the provided 6-way empty connector, which is attached to the 6-way Accessory connector on the Dash Harness, and terminals "A" or "B" to add power wires (not included in kit) for the following optional systems:

Wire Color	Printing	Fuse #	Fuse Block Cover	Fuse rating	Description
Tan	FUEL PUMP	10	Fuel Pump	20A	Fused 12 volt IGNITION feed for fuel pump (may also be used to feed power to another ignition circuit).
Orange	POWER SEATS	2	Pwr Seats	30A	Fused 12 volt BATTERY feed for power seats (may also be used to feed power to another battery circuit).
Red	POWER LOCKS	8	Pwr Locks	15A	Fused 12 volt BATTERY feed for power door locks (may also be used to feed power to another battery circuit).
Pink	POWER WINDOWS	15	Pwr Window	30A	Fused 12 volt ACCESSORY feed for power windows (may also be used to feed power to another accessory circuit).
Orange	(No Printing)	7	Bat-Spare	30A	Fused 12 volt BATTERY feed (may also be used to feed power to a battery circuit).

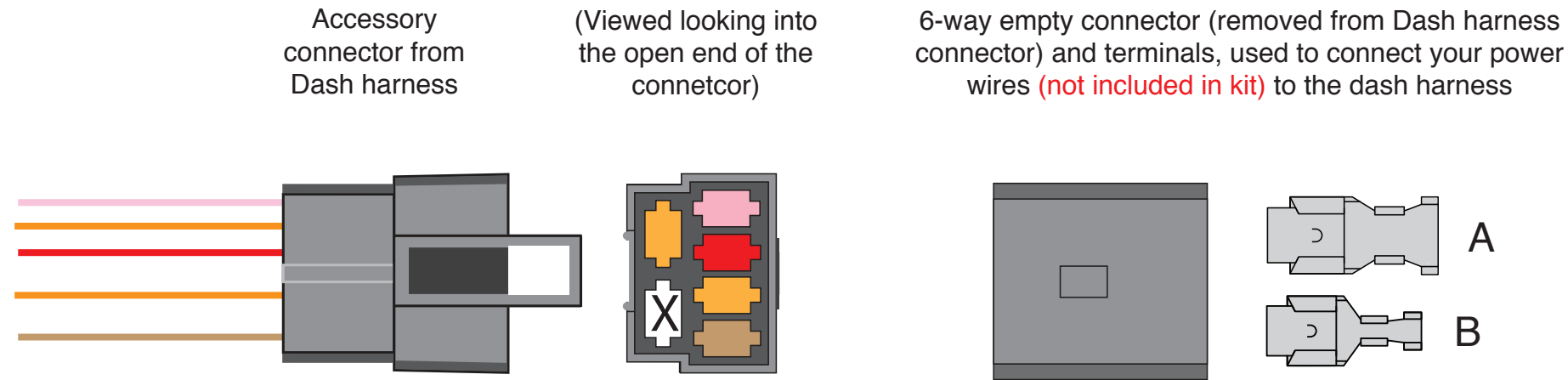

Courtesy light wiring:

Connect the (2) courtesy light wiring extensions "FF" to the courtesy light plugs from the dash harness: The left-hand courtesy plug is at the same branch as the headlight switch, and will mount to the right of the steering column along the bottom of the dash. The right-hand courtesy plug is at the far end of the dash harness, near the glovebox lamp connection and RH door jamb switch connection, and will mount along the bottom of the dash. The (2) courtesy light wiring extensions are found in the dash loose piece bag, part number 92972061.

(2) courtesy light connections from Dash harness

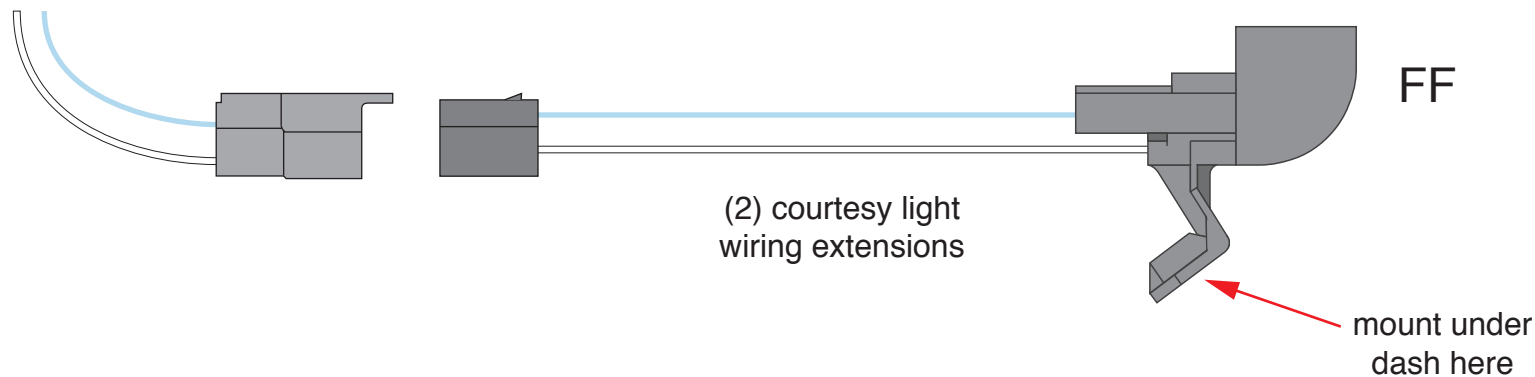

Fog light switch wiring:

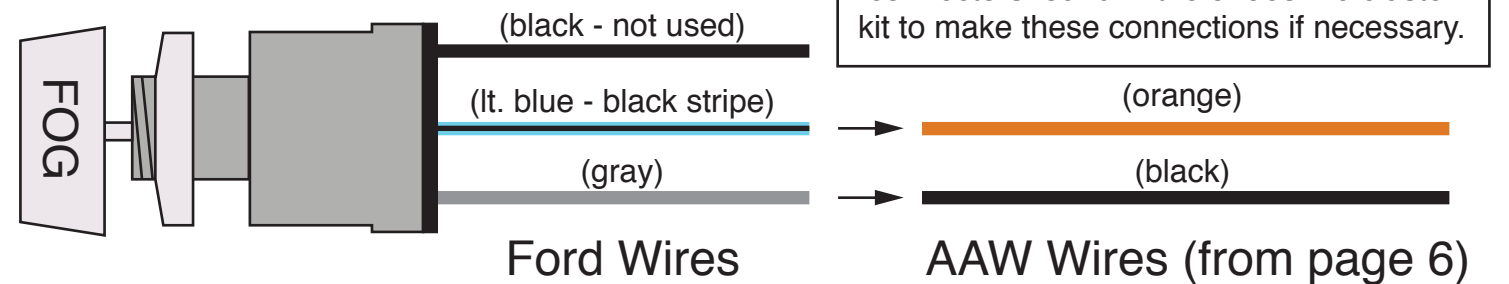

NOTE: The factory Ford fog lamp switch utilized 3 wires: blue with a black stripe, gray, and black. For this application, the AAW orange wire will be connected to the original Ford blue with black stripe wire, and the AAW black wire will be connected to the original Ford gray wire. The original Ford black wire will not be used in this application and should be capped off.



1964-66 Mustang
Classic Update Series
510125 92972102 Rev 4.0 5/8/2020

Dash/Main harness installation instructions:

Neutral Safety Switch and Backup Switch wiring:

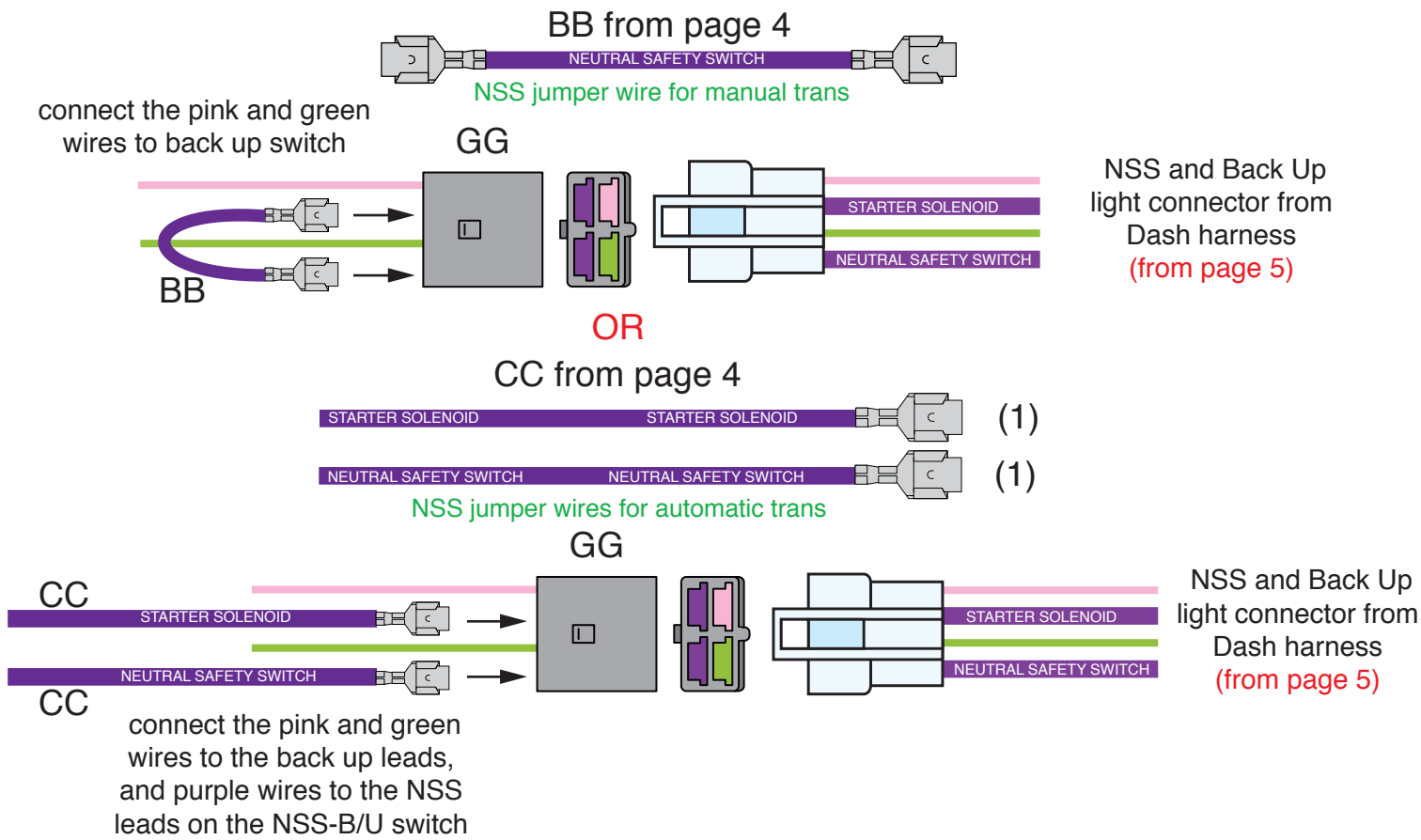

Shown is a typical Ford NSS and Back Up Switch.

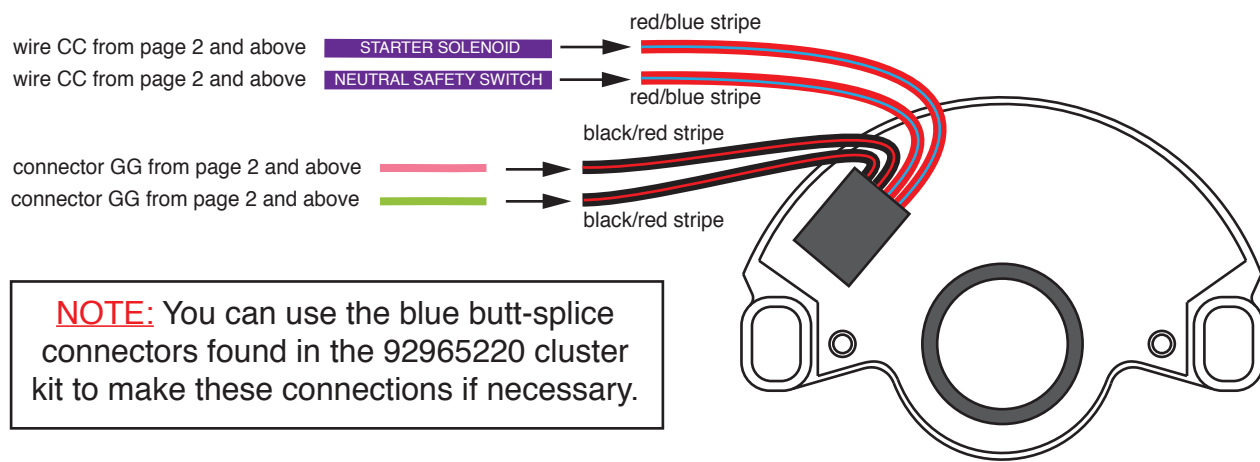

1964-66 Mustang
Classic Update Series
510125 92972102 Rev 4.0 5/8/2020



www.americanautowire.com 856-933-0801

Heater wiring:

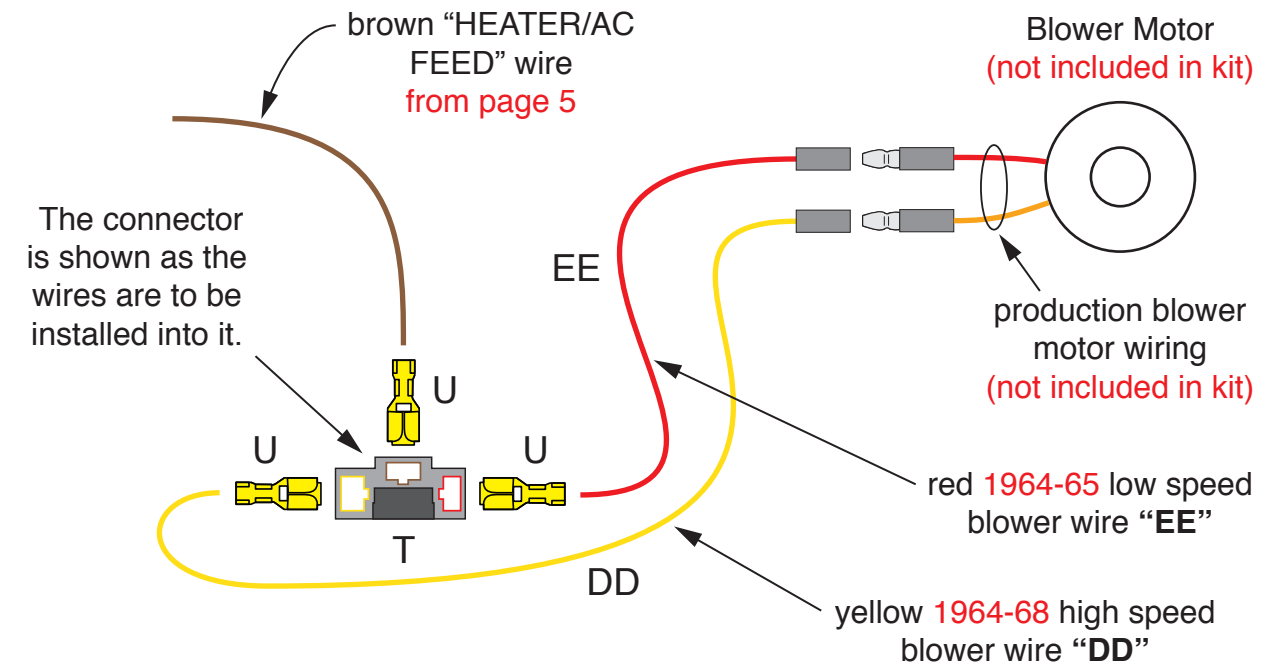



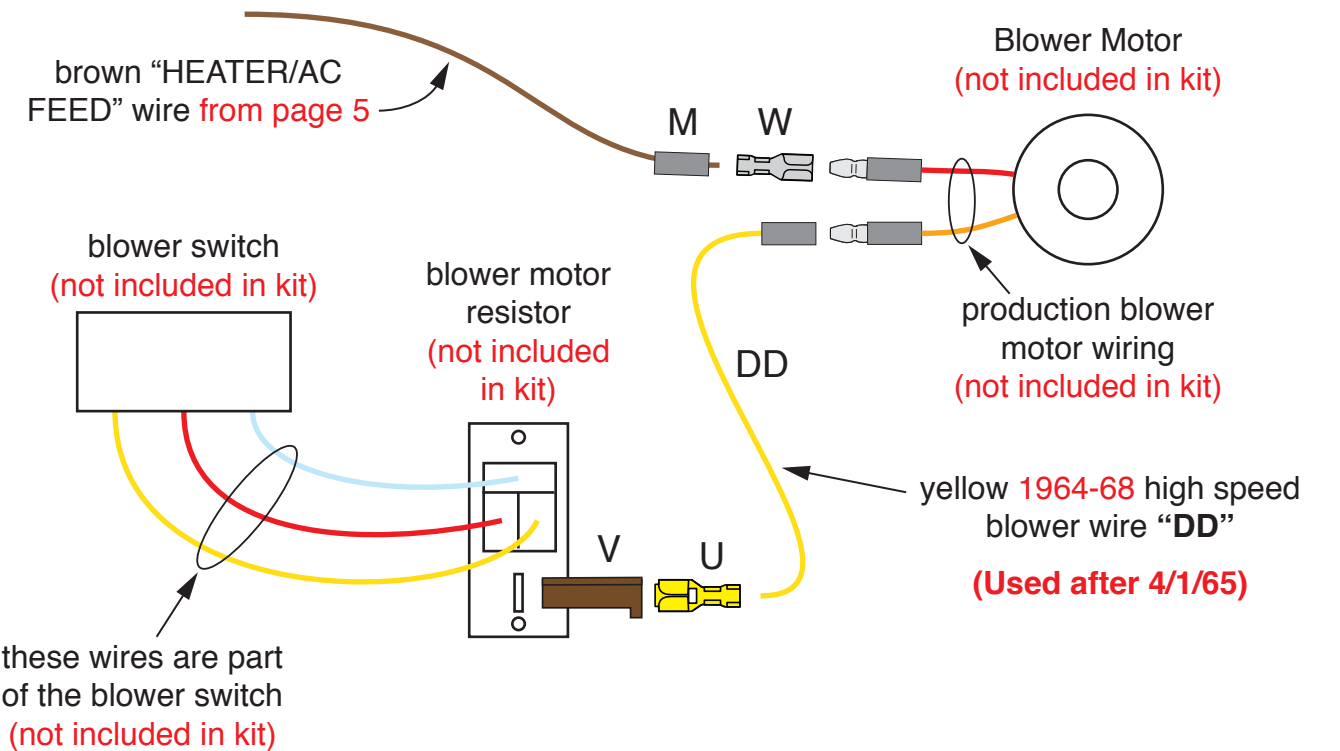



'64 1/2 & early production '65, 2 speed Heater motor connections

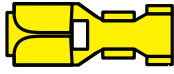
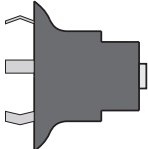
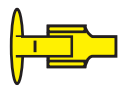
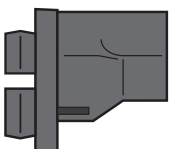
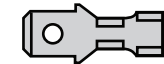

'65 & '66, 3 Speed Heater motor connections with resistor

Gauge Cluster harness installation instructions:

Shown below, are the supplied misc. terminals, plastic connector bodies, light sockets and hardware that will be used to complete your Gauge Cluster harness connections. They are itemized and referred to on this page, just as they are on the following pages of this Gauge Cluster instruction set.

- | | | | | | |
|---|---|--|---|---|---|
| A |  | (58 series single female conn, 1 pc.) | G |  | (58 series double female terminal, 2 pcs.) |
| B |  | (light socket, 10 pcs.) | H |  | (terminal rivet, 15 pcs.) |
| C |  | (plastic light socket, 2 pcs.) | J |  | (.25 male terminal, 2 pcs.) |
| D |  | (spring, plastic light socket, 3 pcs.) | K |  | (terminal, plastic light socket ground, 3 pcs.) |
| E |  | (rubber sleeve, 1 pc.) | L |  | (shrink tubing, 1 pc.) |
| F |  | (splice clip, 3 pcs.) | | | |



**American
Autowire**

www.americanautowire.com 856-933-0801

1964-66 Mustang

Classic Update Series

510125

92972102 Rev 4.0 5/8/2020

How to install light sockets and light socket terminals.

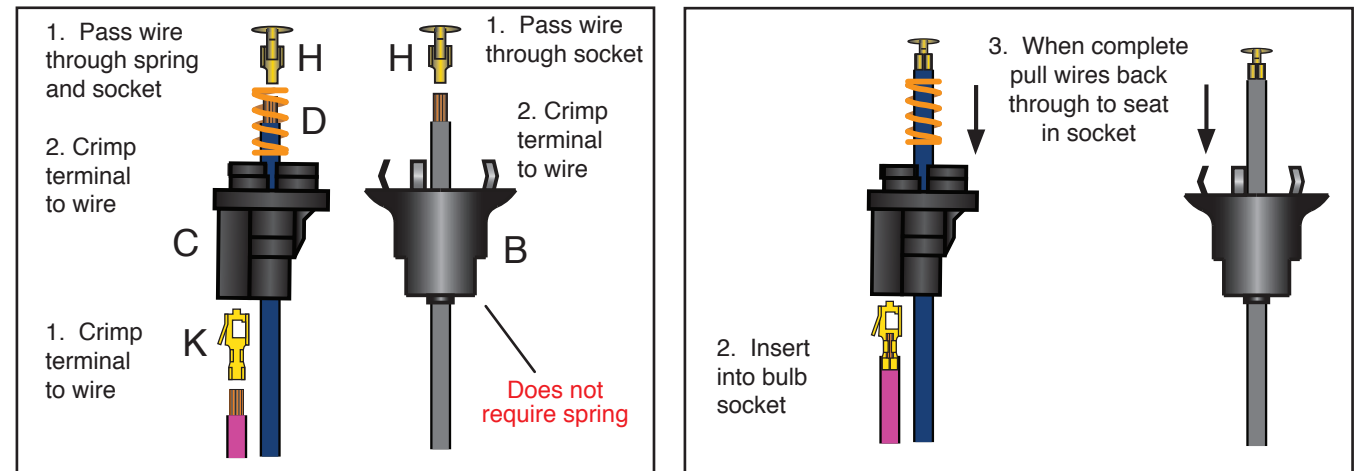

How to use the splice clip to join multiple wires.

Below is just an **EXAMPLE** of how to use the splice clip and shrink tubing; see your specific application on the following pages for actual splice information.

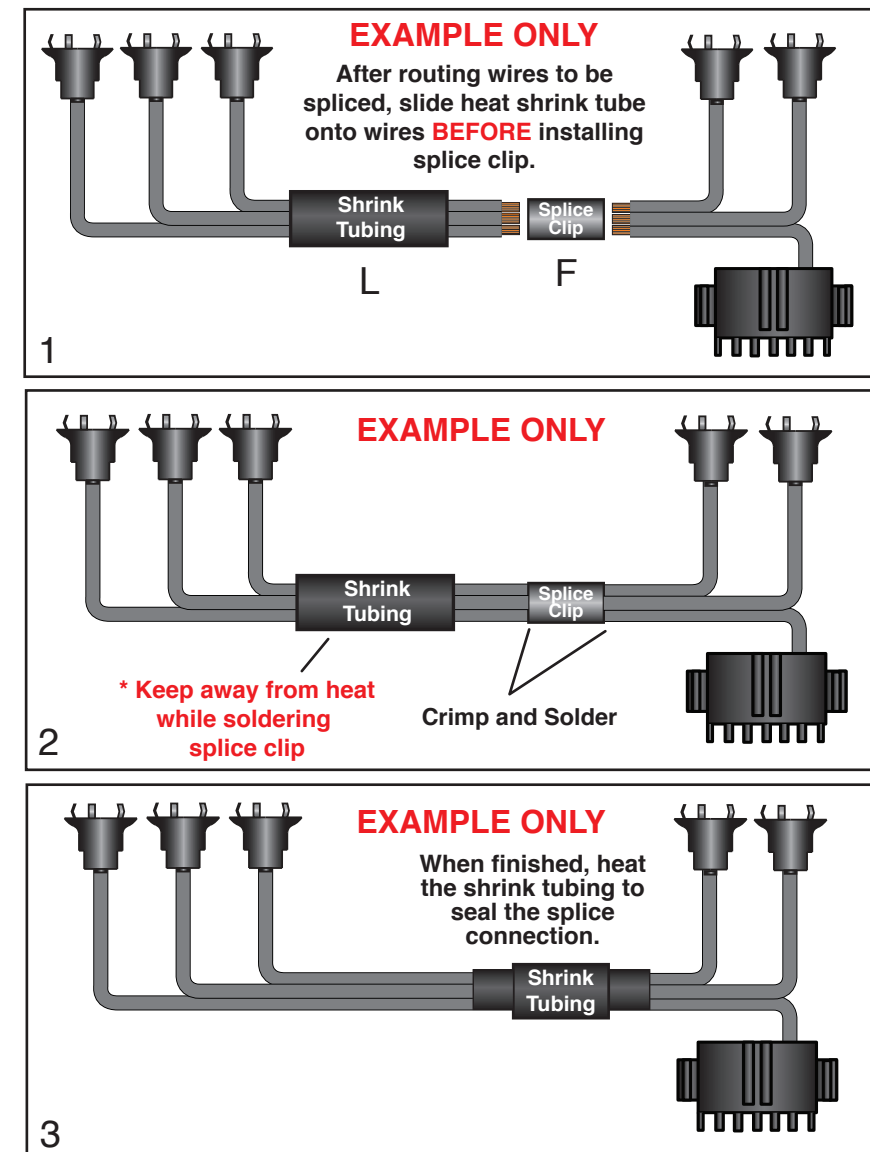

Gauge Cluster harness (aftermarket gauges) installation instructions:

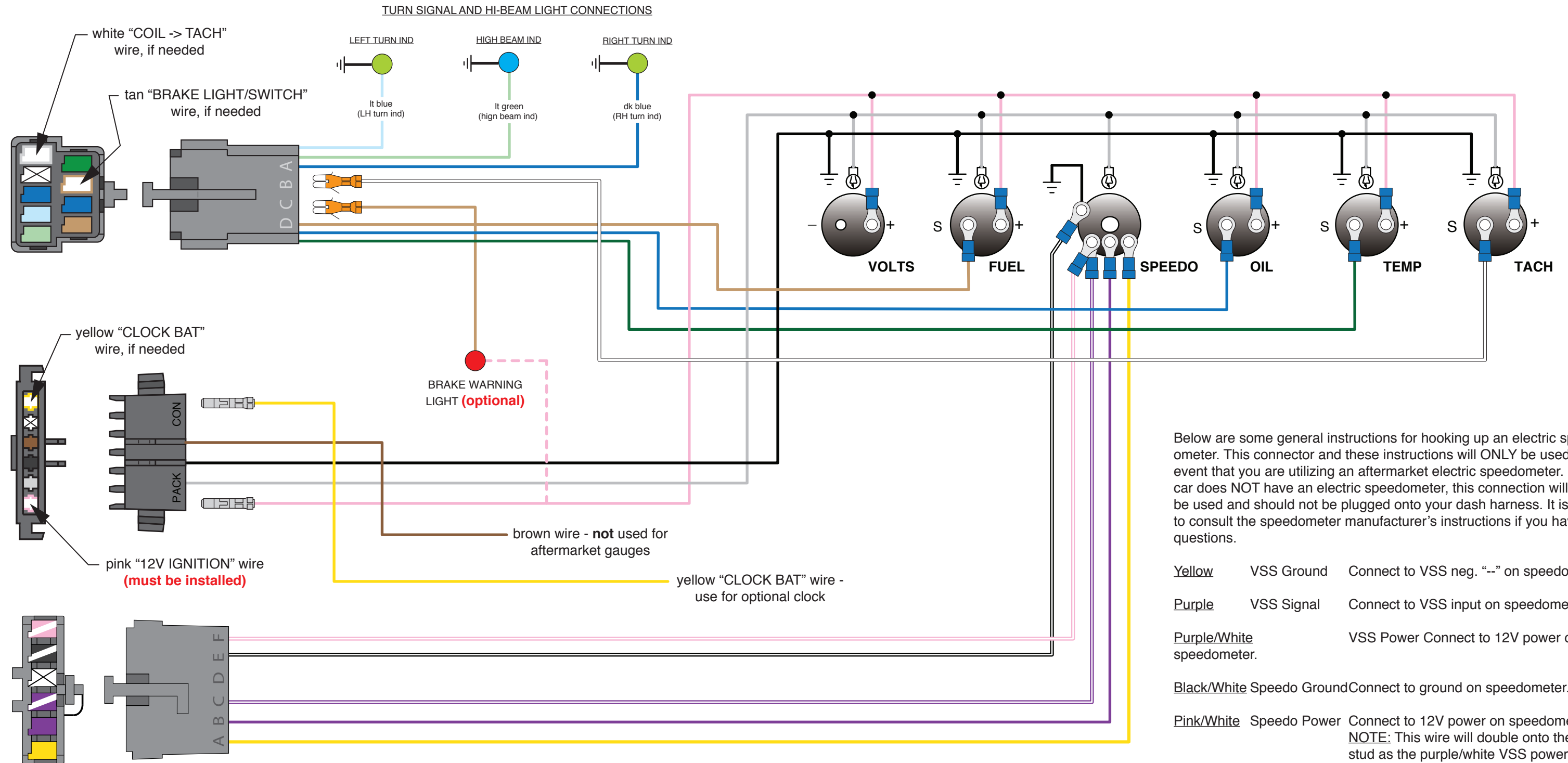

Below are some general instructions for hooking up an electric speedometer. This connector and these instructions will ONLY be used in the event that you are utilizing an aftermarket electric speedometer. If your car does NOT have an electric speedometer, this connection will NOT be used and should not be plugged onto your dash harness. It is best to consult the speedometer manufacturer's instructions if you have any questions.

- Yellow** VSS Ground Connect to VSS neg. "--" on speedometer.
- Purple** VSS Signal Connect to VSS input on speedometer.
- Purple/White** VSS Power Connect to 12V power on speedometer.
- Black/White** Speedo Ground Connect to ground on speedometer.
- Pink/White** Speedo Power Connect to 12V power on speedometer.
NOTE: This wire will double onto the same stud as the purple/white VSS power wire from above.

See pages 13-15 for stock dash cluster applications



American Autowire

Gauge Cluster harness installation instructions:

1964 1/2 & 1965 Mustang with fuel and temp gauge, oil and gen lights & generator

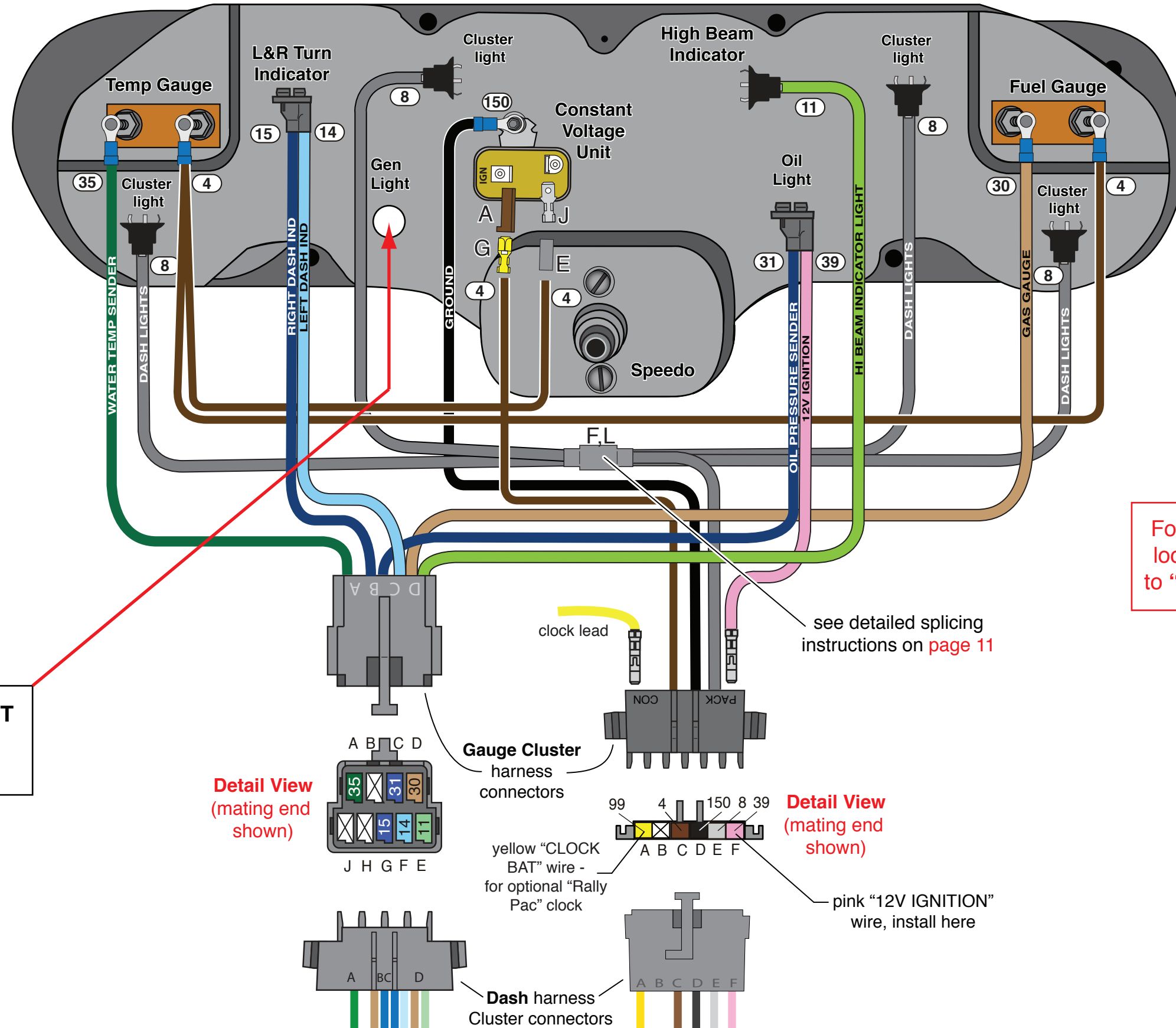

For proper wire locations, refer to "Detail View"

GEN. LIGHT NOT SUPPORTED IN THIS KIT

see detailed splicing instructions on page 11



www.americanautowire.com 856-933-0801

1964-66 Mustang
 Classic Update Series
510125 92972102 Rev 4.0 5/8/2020

Gauge Cluster harness installation instructions:

1965 Mustang with fuel and temp gauge, oil and gen lights & alternator

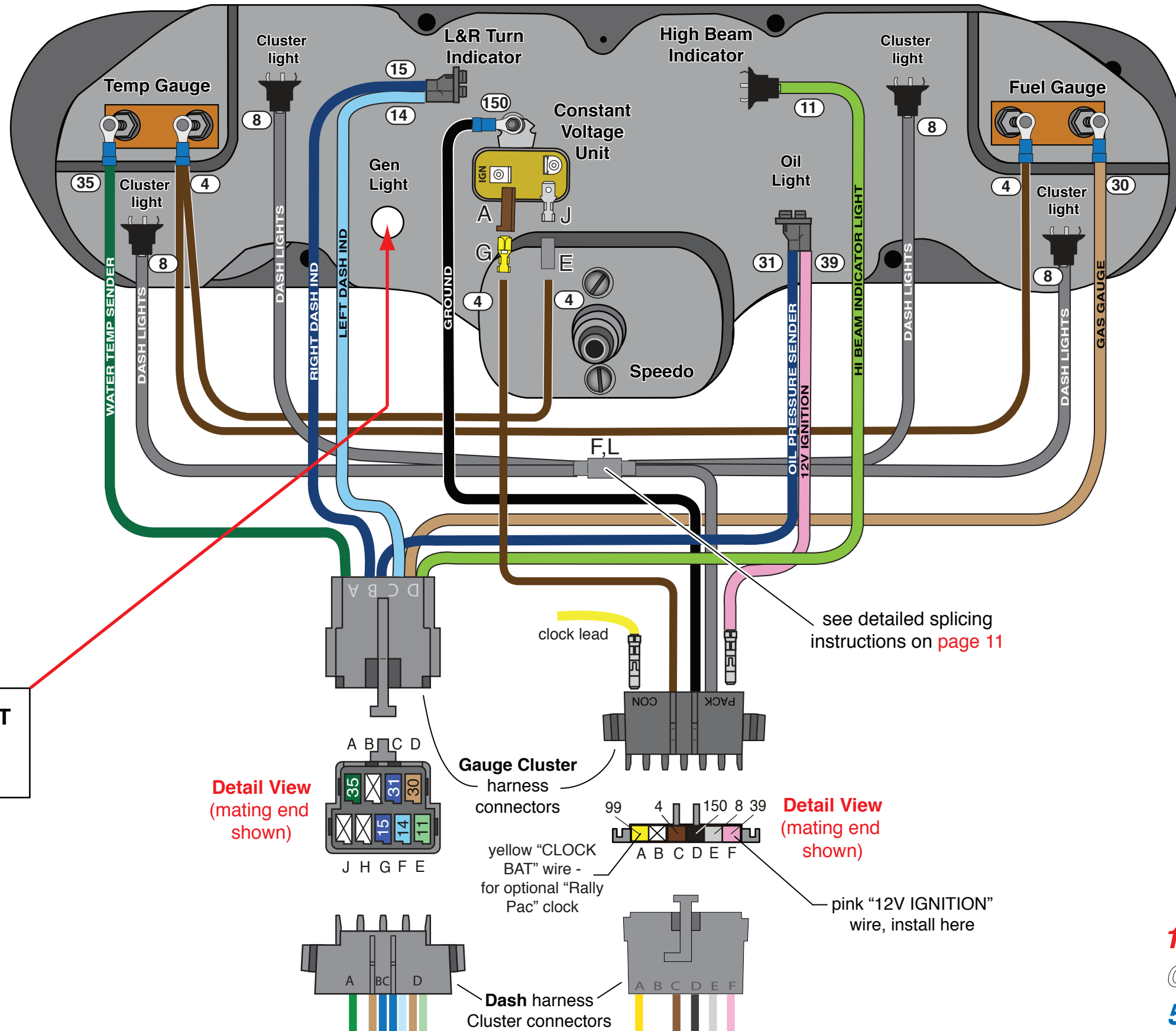

For proper wire locations, refer to "Detail View"

GEN. LIGHT NOT SUPPORTED IN THIS KIT

see detailed splicing instructions on page 11

Detail View (mating end shown)

Detail View (mating end shown)

Gauge Cluster harness connectors

Dash harness Cluster connectors

yellow "CLOCK BAT" wire - for optional "Rally Pac" clock

pink "12V IGNITION" wire, install here



www.americanautowire.com 856-933-0801

1964-66 Mustang
 Classic Update Series
510125 92972102 Rev 4.0 5/8/2020

Gauge Cluster harness installation instructions:

1965 Mustang with factory gauges; 1966 Mustang all

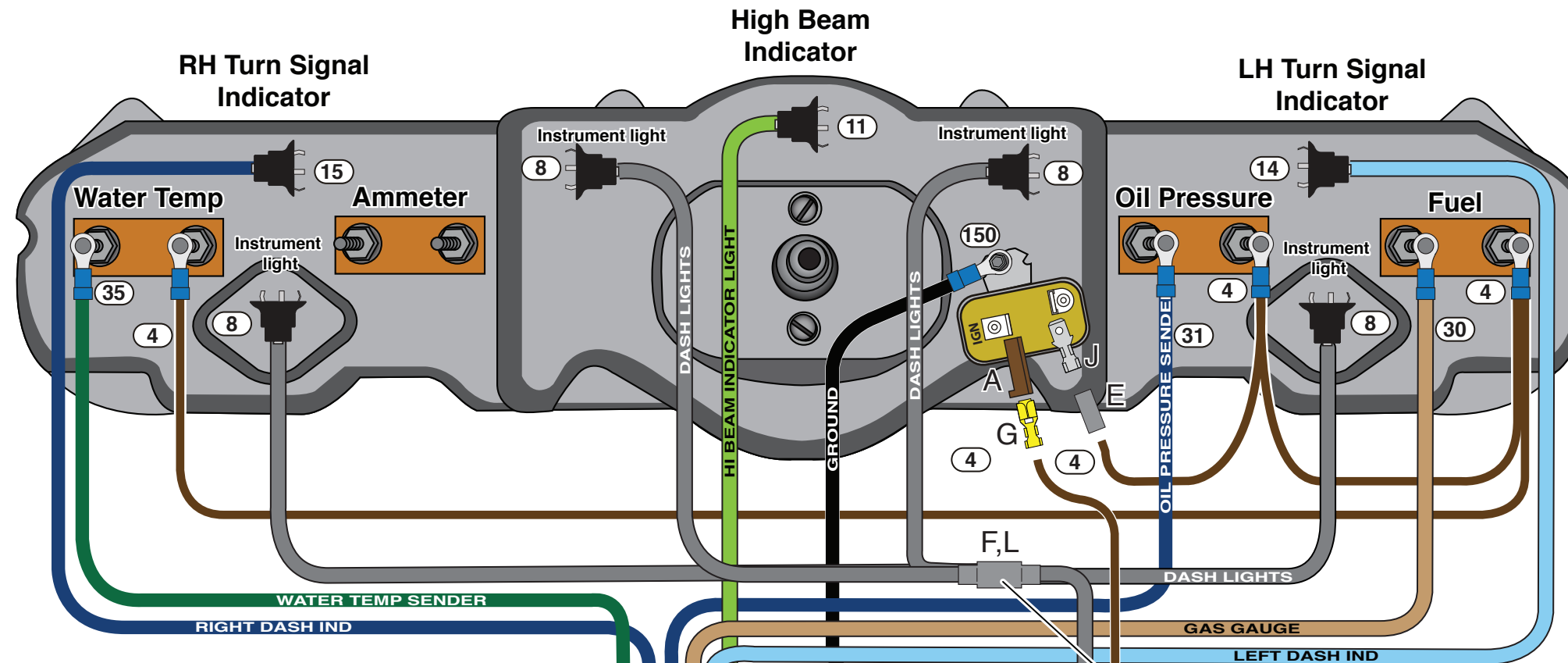

AMMETER NOT SUPPORTED IN THIS KIT

For proper wire locations, refer to "Detail View"

see detailed splicing instructions on page 11

Detail View (mating end shown)

Detail View (mating end shown)

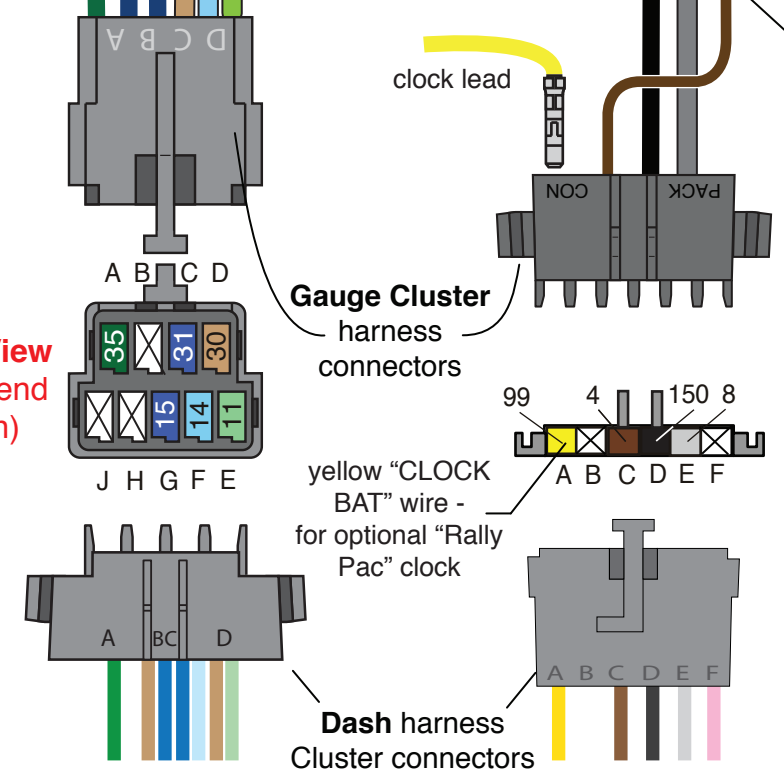





www.americanautowire.com 856-933-0801

1964-66 Mustang
Classic Update Series

510125 92972102 Rev 4.0 5/8/2020

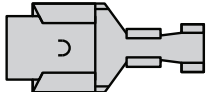
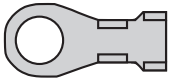
Engine harness installation instructions:

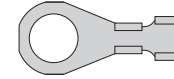
Shown below, are the supplied misc. terminals, sleeves, plastic connector bodies and wires, included in the Engine Harness and Loose Piece bags, that will be used to complete your Engine harness connections. They are itemized and referred to on this page, just as they are on the following pages of this Engine instruction set.

- A  (56 Series single female connector, 2 pcs)
- B  (56 Series single female terminal, 4 pcs)
- C  (ring terminal, 3 pcs)
- D  (large rubber sleeve, 2 pcs)
- E  (ring terminal, 4 pcs)
- F  (small rubber sleeve, 2 pcs)

Engine harness Connections:

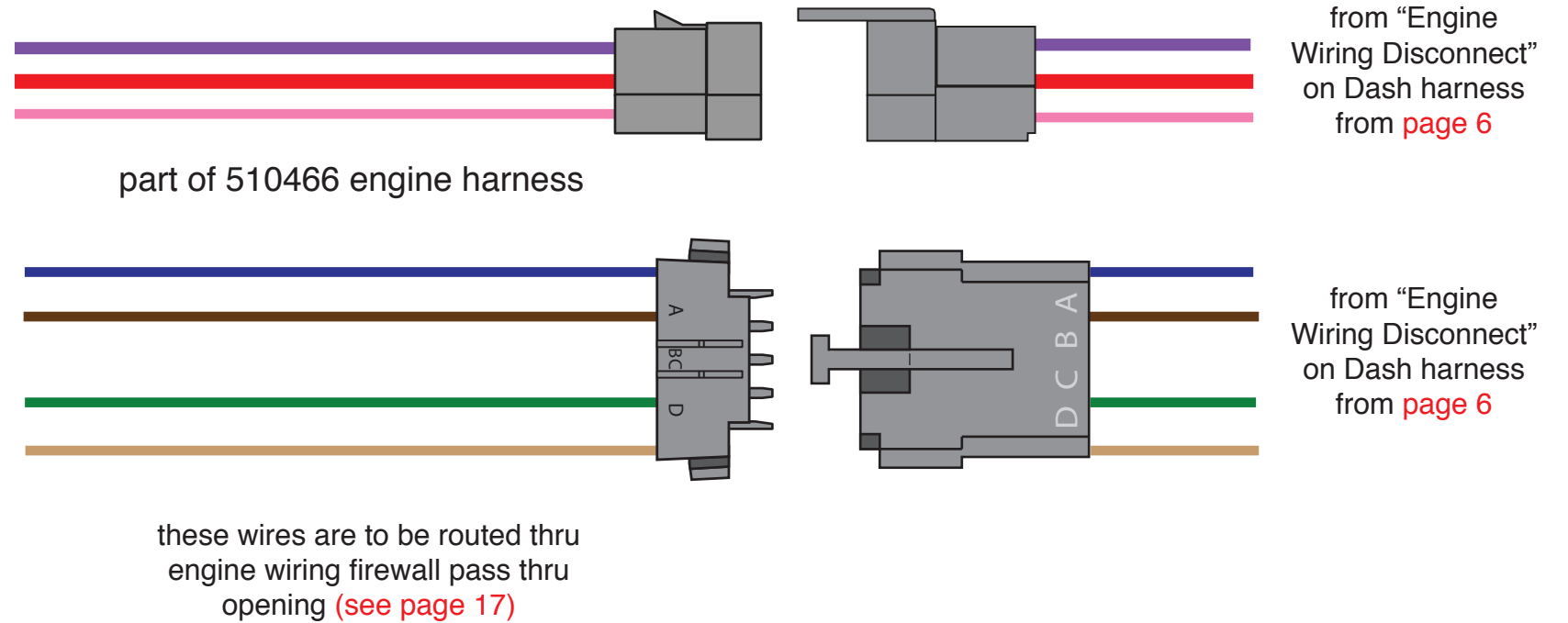

Vehicle Speed Sensor and Tach wiring:

route these wires (along with the other Engine harness wires) thru the engine wiring, firewall pass thru opening (see page 17)

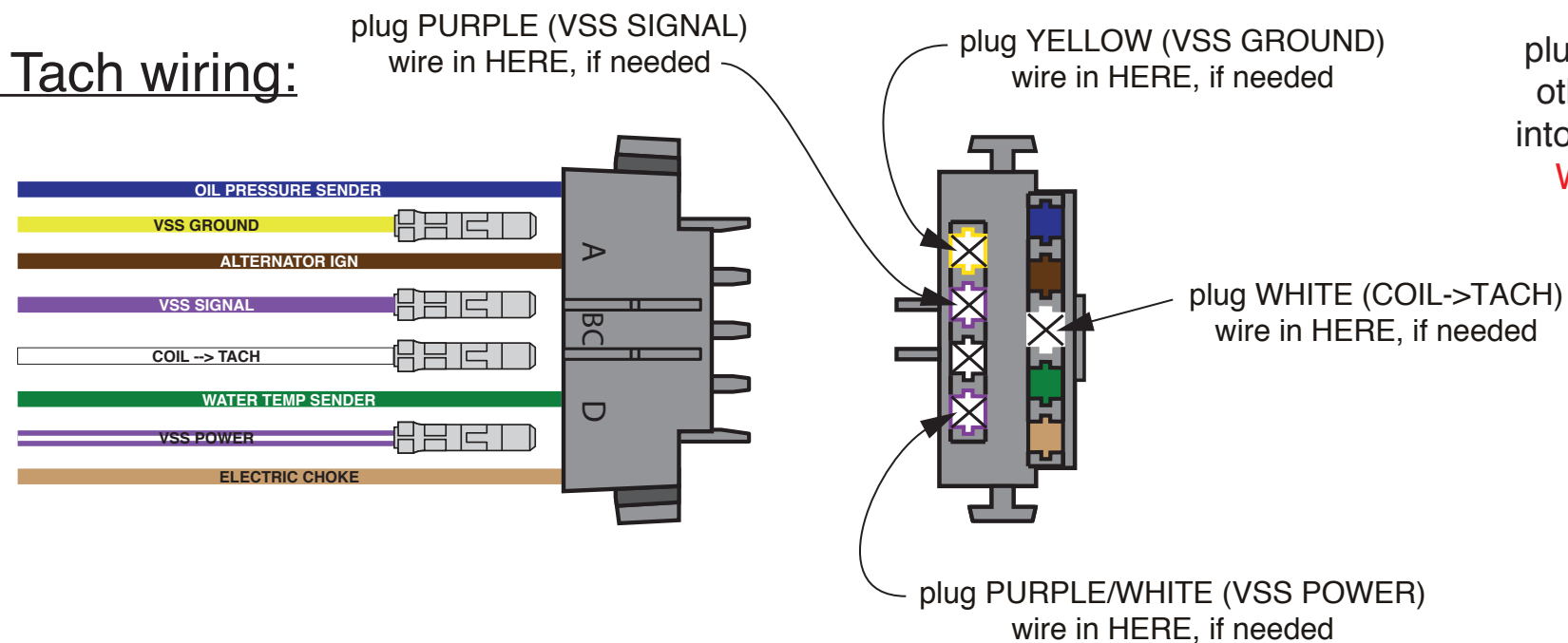

plug this connector (along with the other Engine harness connector) into the Dash harness (see "Engine Wiring Disconnect" on page 6)



www.americanautowire.com 856-933-0801

1964-66 Mustang
 Classic Update Series
510125 92972102 Rev 4.0 5/8/2020

Engine harness installation instructions:

Install grommet (see item "P" on page 4 of Dash harness loose piece kit) into the firewall pass thru opening, then pass the engine wiring thru the grommet (not including relay blocks). After wires are passed thru, apply silicone sealer to this area to make a weather-tight seal

1964-66 Mustang
 Classic Update Series
510125 92972102 Rev 4.0 5/8/2020





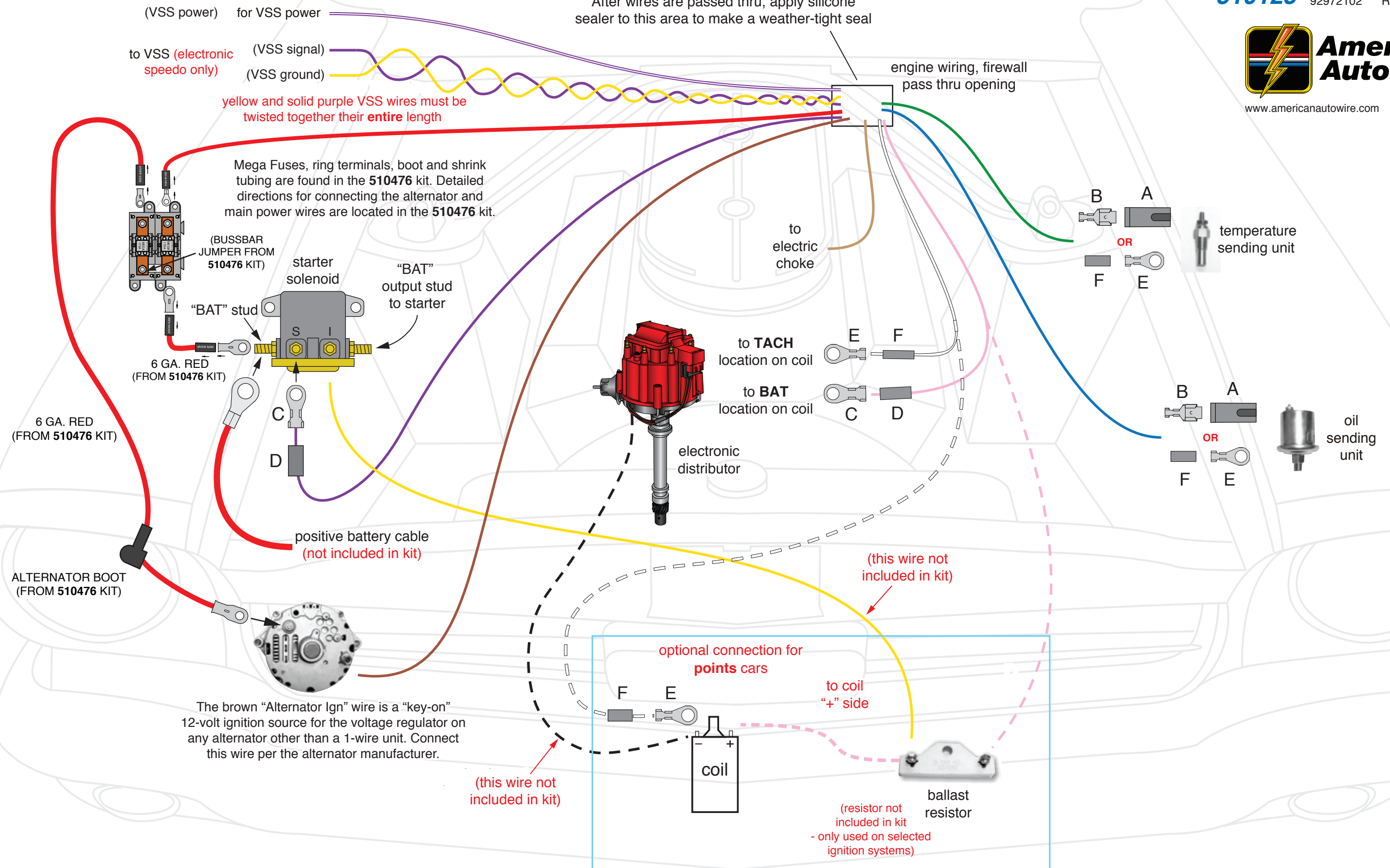





www.americanautowire.com 856-933-0801

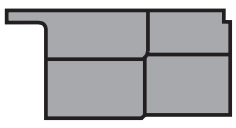

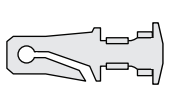
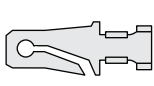
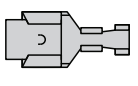
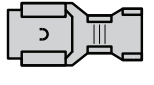
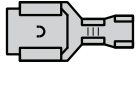
Front Light harness installation instructions:

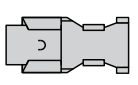
Shown below, are the supplied misc. terminals, plastic connector bodies, and pigtails, included in the Front Light Harness and Loose Piece bags, that will be used to complete your Front Light harness connections. They are itemized and referred to on this page, just as they are on the following pages of this Front Light instruction set.

<p>A  (56 Series double female connector, 2 pcs)</p>	<p>M  (67-68 hood mounted directional lights pigtail [not used on 64-66], 1 pc)</p>	<p>N  (headlight connector assy, 2 pcs)</p>
<p>B  (56 Series double male connector, 2 pcs)</p>		
<p>C  (56 Series single female connector, 2 pcs)</p>		
<p>D  (56 Series single male terminal, 5 pcs)</p>		
<p>E  (56 Series double male terminal, 3 pcs)</p>		
<p>F  (56 Series single female terminal, 7 pcs)</p>		
<p>G  (59 Series double female terminal, 4 pcs)</p>		
<p>H  (59 Series single female terminal, 4 pcs)</p>		
<p>J  (56 Series single female connector, 1 pc)</p>		
<p>K  (56 Series double female terminal, 2 pcs)</p>		
<p>L  (BCAT assy - Brake pressure differential warning switch, 1 pc)</p>		

Front light harness (and 1967-68 hood mounted directional light wiring only):

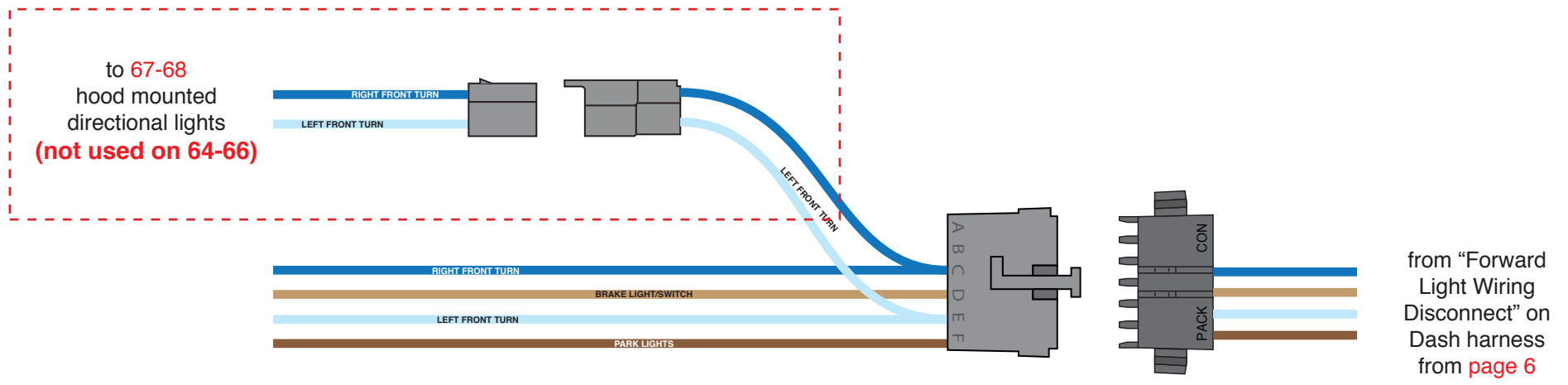

part of 510465 front light harness

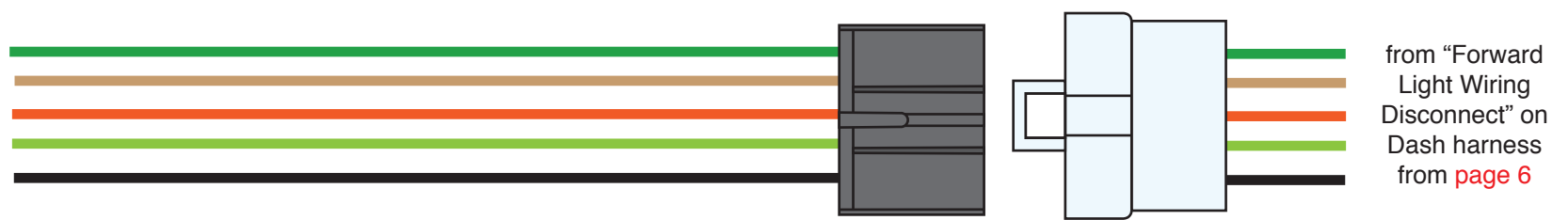

these wires are to be routed thru forward lamp wiring firewall pass thru opening (see page 19)



www.americanautowire.com 856-933-0801

1964-66 Mustang
 Classic Update Series
510125 92972102 Rev 4.0 5/8/2020

Front Light harness installation instructions:



www.americanautowire.com 856-933-0801

1964-66 Mustang
Classic Update Series
510125 92972102 Rev 4.0 5/8/2020

This plug under the dash
from Front Light harness
is for 67-68 hood
mounted directional
lights.
(not used on 64-66)



firewall pass thru opening
for forward lamp, electric
fan, horn and brake switch
warning wiring.

Install grommet (see item "P" on
page 4 of Dash harness loose piece
kit) into the firewall pass thru opening,
then pass the forward wiring thru the
grommet **(not including relay
blocks)**. After wires are passed thru,
apply silicone sealer to this area to
make a weather-tight seal.

to brake pressure
sending unit
(if needed)

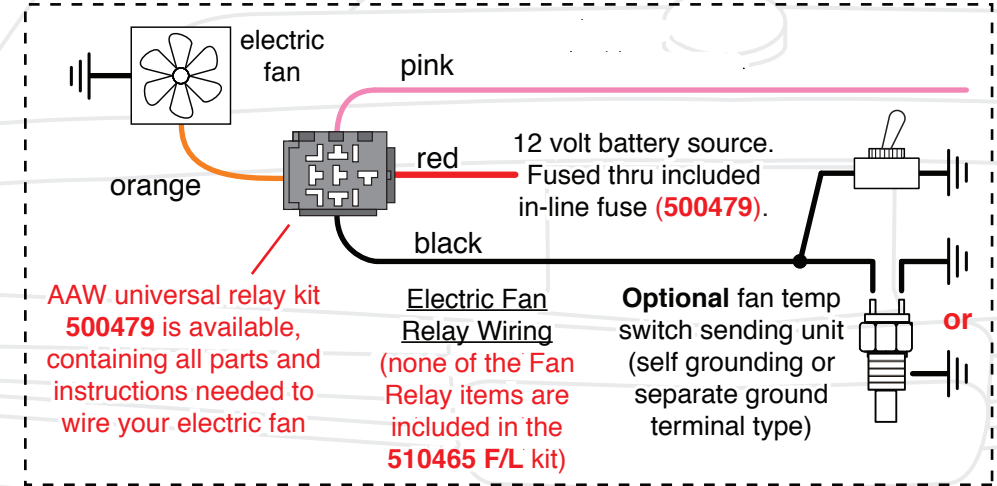
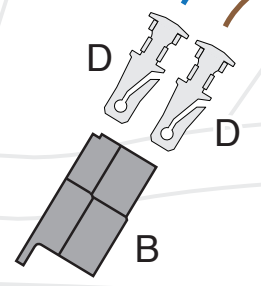
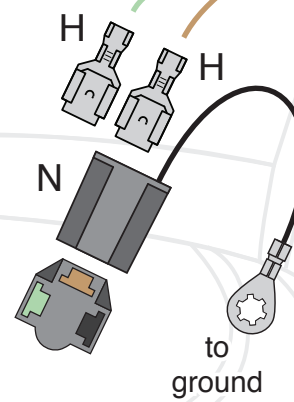
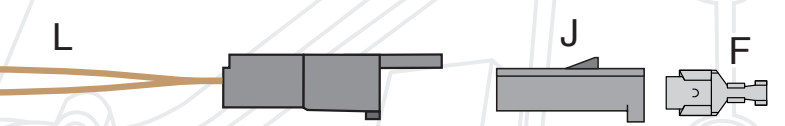

fused 12V
ignition source
for fan relay

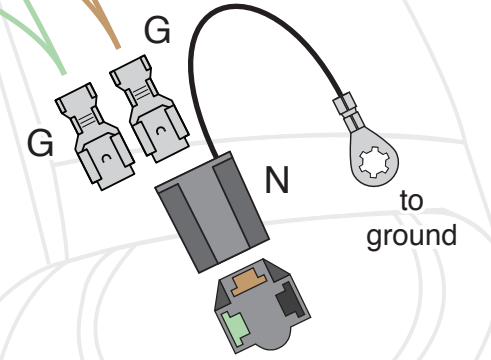
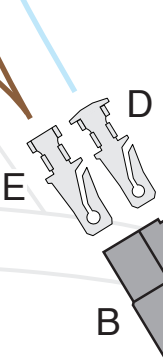

to chassis
ground

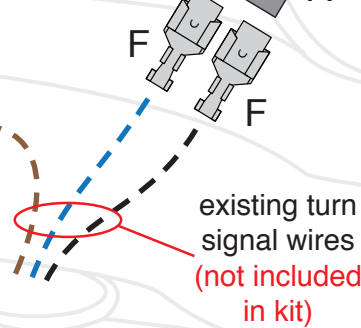

existing turn
signal wires
**(not included
in kit)**

to optional
second horn

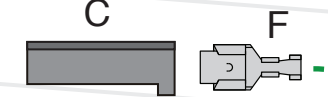

Connect this black "FOG LAMPS"
wire to your fog light power wires. If
the fog lights have separate ground
wires, you must supply them as they
are **not included in this kit**

to horn

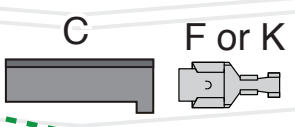

to chassis
ground

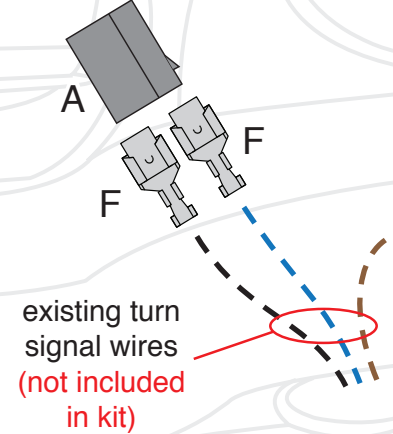

existing turn
signal wires
**(not included
in kit)**

Rear Body harness installation instructions:

Shown below, are the supplied misc. terminals, plastic connector bodies, clamps and wire extensions, included in the Rear Body Harness and Loose Piece bags, that will be used to complete your Rear Body harness connections. They are itemized and referred to on this page, just as they are on the following pages of this Rear Body instruction set.

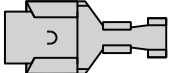
A  (56 Series single female terminal, 6 pcs)

B  (56 Series double female connector, 2 pcs)

C  (56 Series single male connector, 2 pcs)

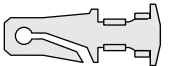
D  (56 Series single male terminal, 8 pcs)

E  (56 Series double female terminal, 3 pcs)

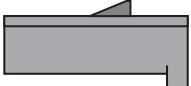
F  (56 Series single female connector, 2 pcs)

G  (single female terminal, 7 pcs)

H  (male bullet terminal, 3 pcs)

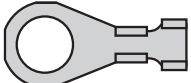
J  (ring terminal, 2 pcs)

K  (large rubber sleeve, 5 pcs)

L  (small rubber sleeve, 2 pcs)

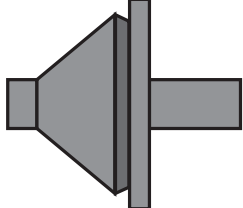
M  (rubber grommet, 1 pc)

N  (56 Series double male connector, 2 pcs)

P  (left tail light extension, 1 pc)
 Wires on actual mold-on connector, may be in either position; either way is acceptable.

R  (right tail light extension, 1 pc)

T  (12V CTSY SW wire, 1 pc)

U  (12V CTSY SW wire, 1 pc)

V  (THIRD BRAKE LIGHT wire, 1 pc)

W  (12V BATTERY-FUSED wire, 1 pc)

Y  (CTS Y GROUND wire, 2 pcs)



www.americanautowire.com 856-933-0801

1964-66 Mustang
 Classic Update Series
510125 92972102 Rev 4.0 5/8/2020

Rear Body harness installation instructions:

1964-66 Mustang
 Classic Update Series
510125 92972102 Rev 4.0 5/8/2020



www.americanautowire.com 856-933-0801

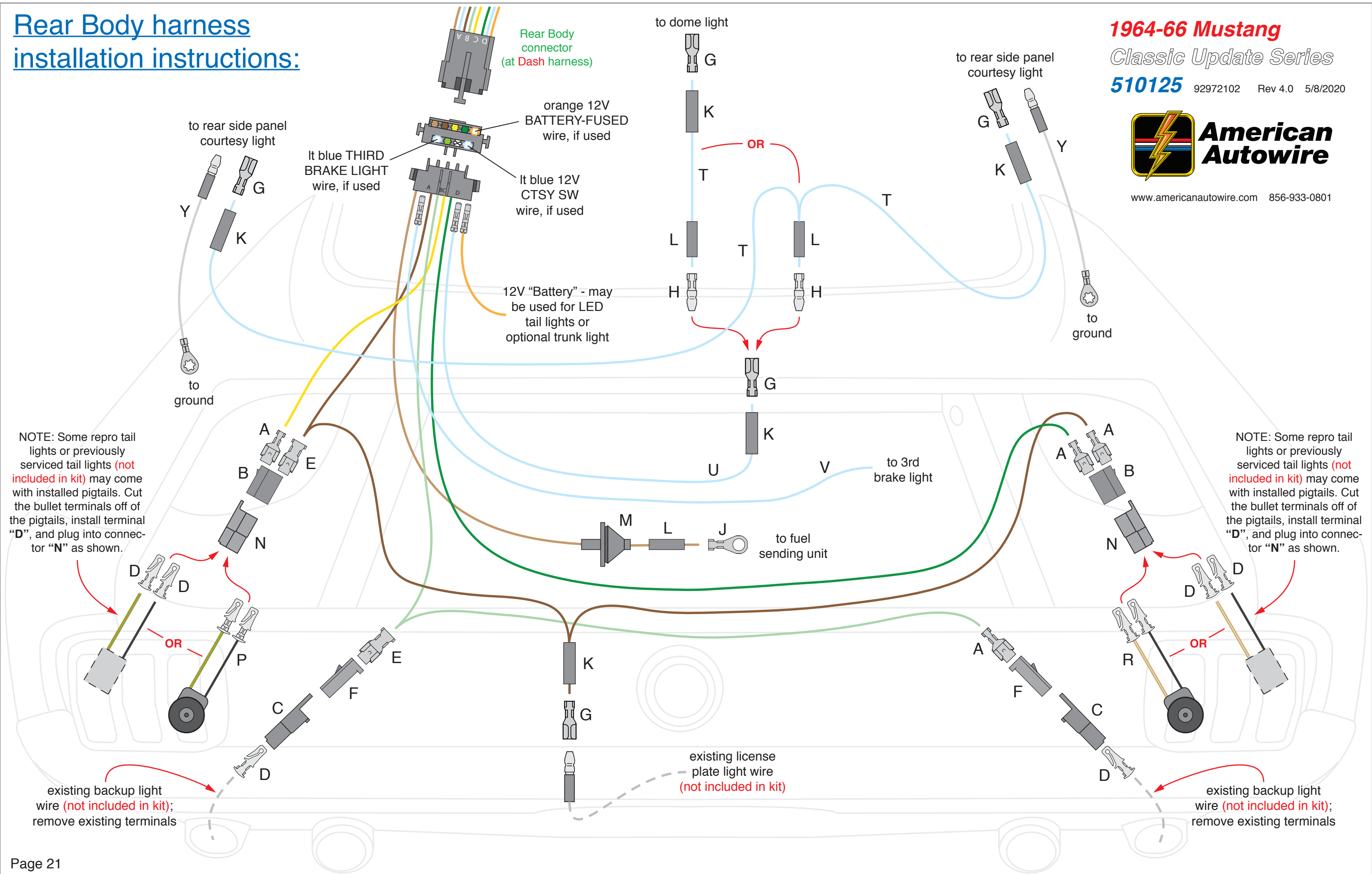

NOTE: Some repro tail lights or previously serviced tail lights (not included in kit) may come with installed pigtails. Cut the bullet terminals off of the pigtails, install terminal "D", and plug into connector "N" as shown.

NOTE: Some repro tail lights or previously serviced tail lights (not included in kit) may come with installed pigtails. Cut the bullet terminals off of the pigtails, install terminal "D", and plug into connector "N" as shown.

existing backup light wire (not included in kit); remove existing terminals

existing backup light wire (not included in kit); remove existing terminals

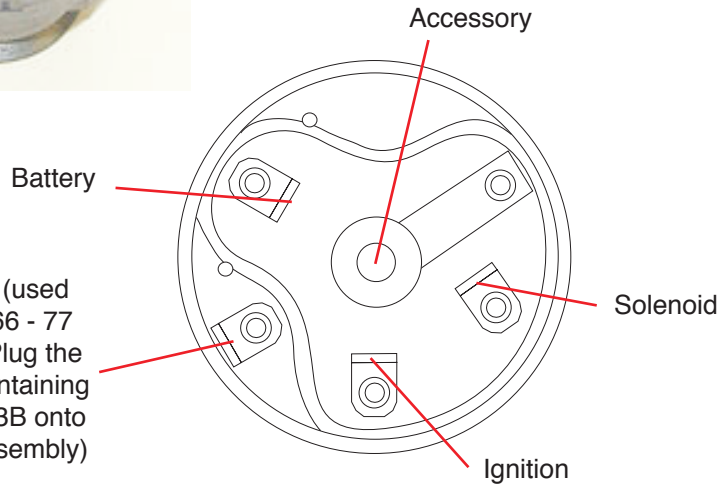

150 Heller Pl #17 W Bellmawr, NJ 08031 856-933-0801

PART #

510128

DESCRIPTION:

Ignition Switch 1964-66
Mustang & 1966-77 Bronco
Classic Update Series

92969235 instruction sheet rev 1.0 6/12/2012

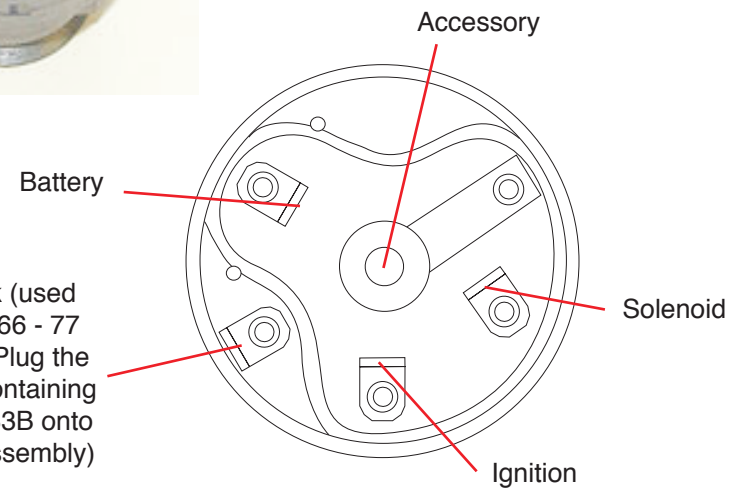

150 Heller Pl #17 W Bellmawr, NJ 08031 856-933-0801

PART #

510128

DESCRIPTION:

Ignition Switch 1964-66
Mustang & 1966-77 Bronco
Classic Update Series

92969235 instruction sheet rev 1.0 6/12/2012

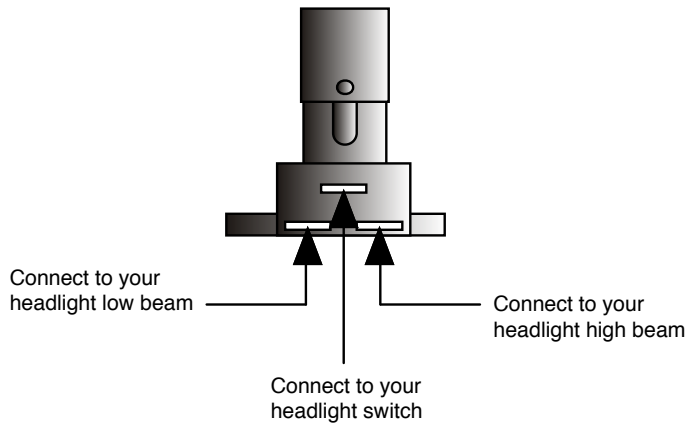

Connect the Dimmer Switch wires as shown above.

1. The top center terminal of the Dimmer Switch is connected to the Headlight switch.
2. The terminal on the right side is connected to your headlight high beam terminal.
3. The terminal on the left side is connected to your headlight low beam terminal.



www.americanautowire.com 856-933-0801

PART #
500042

DESCRIPTION:
DIMMER SWITCH

92964573 Rev 3.1 12/5/2014

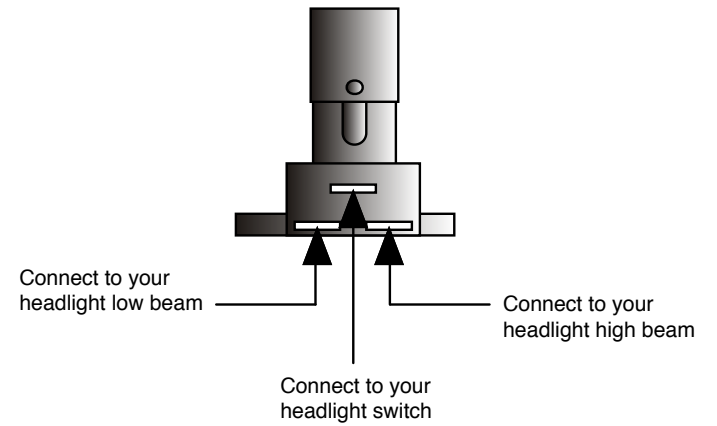

Connect the Dimmer Switch wires as shown above.

1. The top center terminal of the Dimmer Switch is connected to the Headlight switch.
2. The terminal on the right side is connected to your headlight high beam terminal.
3. The terminal on the left side is connected to your headlight low beam terminal.



www.americanautowire.com 856-933-0801

PART #
500042

DESCRIPTION:
DIMMER SWITCH

92964573 Rev 3.1 12/5/2014